

2022

PRODUCT CATALOG

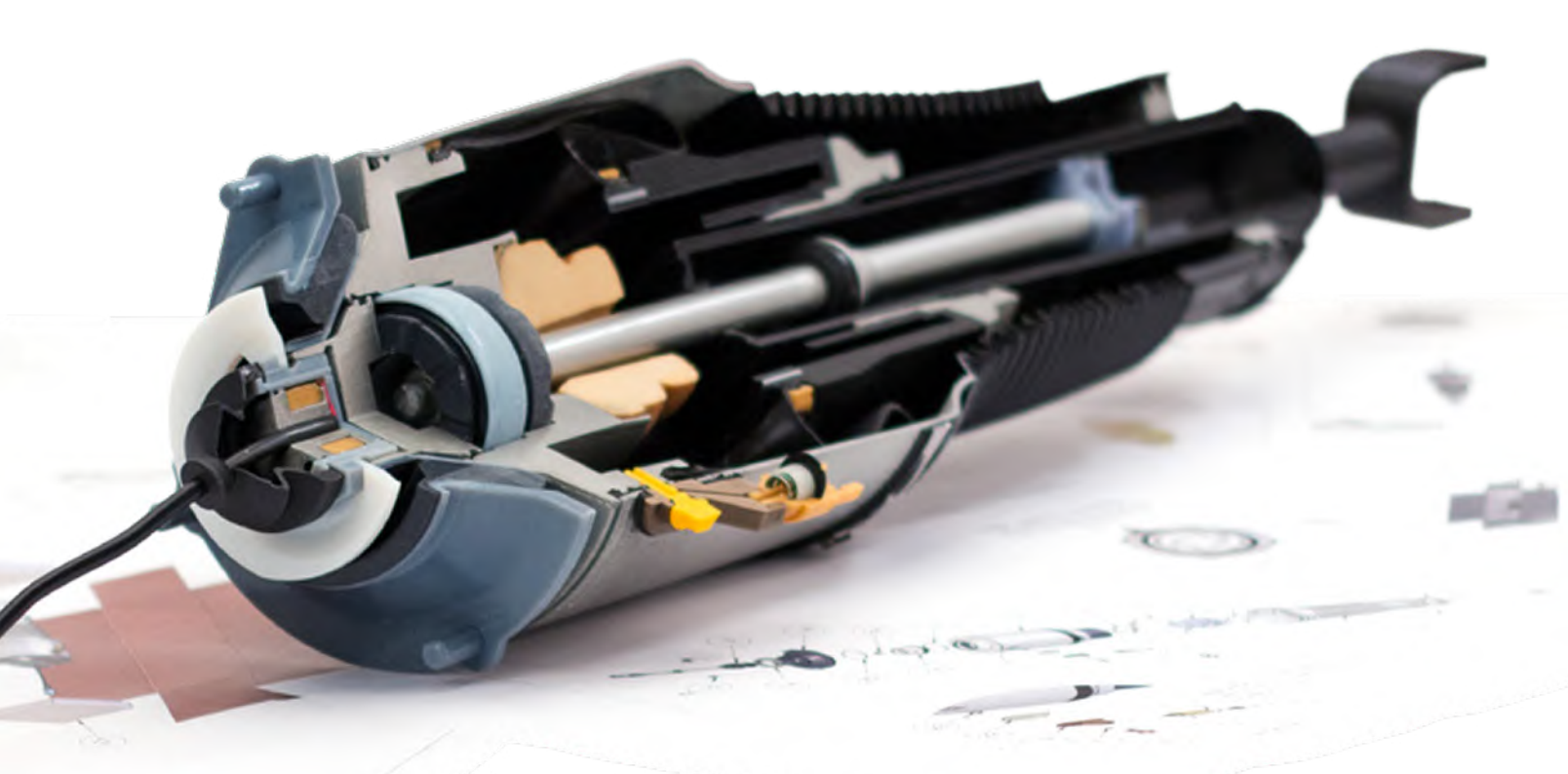



ABOUT ARNOTT

OVER THREE DECADES OF AIR SUSPENSION EXCELLENCE

As the trusted leader in aftermarket air suspension parts and accessories for luxury cars, trucks and SUV's, Arnott has grown into a global brand with over 450 SKU's for more than 800 applications that are sold by leading distributors world-wide.

Founded by the Arnott family in Punta Gorda, Florida, Arnott has always focused on ensuring customer satisfaction by manufacturing high-quality, aftermarket products that offer OE form, fit and function at an affordable price.

For more than three decades, Arnott has demonstrated a commitment to developing exceptional air suspension technology and earning the trust of distributors, installers and end users. Arnott's long list of innovations and patents has cemented our position as a global leader in aftermarket air suspension replacement solutions.

BROADEST COVERAGE OF QUALITY AIR SUSPENSION PRODUCTS & OPTIONS

Arnott offers more than 450 quality aftermarket air suspension products covering over 800 applications including remanufactured OE air struts, Arnott-designed new air struts, magnetic shocks, innovative air springs, OES air suspension compressors, coil spring conversion kits, valve blocks and ride height sensors.

WARRANTY

Arnott's Warranty is the gold standard in the automotive aftermarket industry.

For our customers in the United States and Canada, Arnott offers a Limited Lifetime Warranty on all Arnott-branded air springs, new and remanufactured air strut and shock assemblies, coil spring conversion kits and air suspension compressors. Orders from outside the United States and Canada are backed by a Limited Two-Year Warranty.

Arnott's Warranty is non-transferable. Defective parts will be either replaced or repaired if the part is within the warranty period and proof of purchase is provided. Arnott offers a 30-Day Warranty for parts used in commercial vehicles. Improper use or installation is not a manufacturer's defect. Arnott does not warranty air suspension compressors that have burned out due to an air suspension leak, pumps and electrical plugs that were modified, those that have missing labels or that have water damage.

DOING BUSINESS WITH ARNOTT

Our global team works every day to build on the trust and quality the Arnott name has signified to our customers for 30 years. We forge meaningful relationships with every customer and strive to support their continued success. By offering a comprehensive product line at an exceptional value backed by best-in-class support and a trusted global distribution network, Arnott gives its distributors, resellers and installers the necessary tools to maximize their growth opportunities.

Table of Contents	
About Arnott	1
Why Choose Arnott	2
Product Features	101-105
Contact Arnott	106

Anatomy of Air Suspension	
Overview	20
Air Springs	32
New Air Struts	43
Remanufactured Air Struts	62
Compressors	86

THE ARNOTT ADVANTAGE

Since 1989, Arnott Air Suspension has been the trusted industry leader in aftermarket air suspension parts and accessories for luxury cars, trucks and SUVs.

Arnott delivers exceptional innovation to the global aftermarket industry. Our state-of-the-art manufacturing and remanufacturing processes are driven by decades of extensive research and development, now housed in a 60,000-square-foot R&D facility. With a trusted global network of premier auto parts distributors, Arnott products have unparalleled availability in the marketplace. Our leadership in the industry is the result of unwavering dedication to:

- High quality aftermarket products that offer OE form, fit and function at an affordable price
- Professional, multi-lingual US-based customer service
- Demonstrated engineering, manufacturing & management expertise
- Superior Limited Lifetime Warranties

Arnott Air Suspension Products for:	
Acura*	3
Audi*	4-12
Bentley*	13-14
BMW*	14-18
Buick*	19
Cadillac*	21-27
Chevrolet*	28-31
Citroën*	33
Ford*	33-36
GMC*	36-39
Hummer*	40
Infiniti*	41
Iveco*	41
Jaguar*	42
Jeep*	44-45
Lamborghini*	46
Land Rover*	46-52
Lexus*	53-56
Lincoln*	56-61
Maybach*	61
Mercedes-Benz*	63-84
Mercury*	85
Nissan*	87
Oldsmobile*	87
Peugeot*	88
Pontiac*	88
Porsche*	89-93
Ram*	93-94
Saab*	94
Tesla*	95-96
Toyota*	96-97
Volkswagen*	98-99
Volvo*	100

WHY CHOOSE ARNOTT

INFORMATION WITHIN REACH:











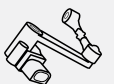

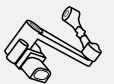

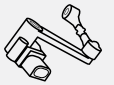

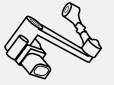

Get the specs you need instantly with detailed product information on our website. Arnott products can also be found in standardized industry data feeds via ACES (Aftermarket Catalog Exchange Standard) and PIES (Product Information Exchange Standard). Need a custom ordering solution? Our catalog team can provide customized spreadsheets or feeds.

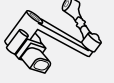
RELIABLE DISTRIBUTION:

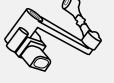
Having multiple Arnott warehouses and partnerships with the industry's foremost distributors, we provide total coverage of North America. This extensive network means fast and dependable deliveries, centralized billing and discounted, tiered pricing.

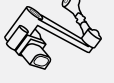
SEAMLESS INSTALLATION:

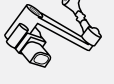





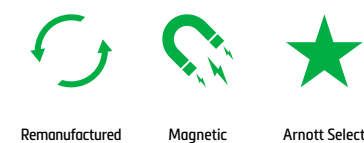
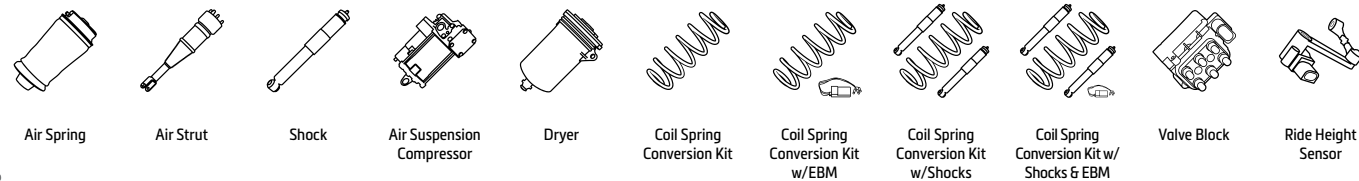



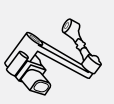

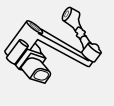

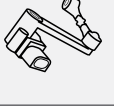

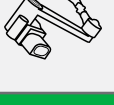

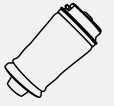

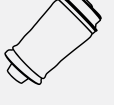
We provide the know-how needed to remove faulty OE products and quickly install Arnott replacement products. Arnott's expert Technical Support is complemented by detailed installation manuals and professional installation videos, making installation easy for technicians of all skill levels.





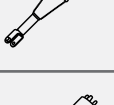

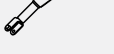



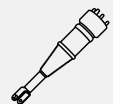

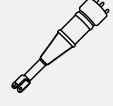



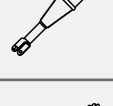

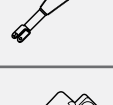
ACURA				
Part #	Product Type	Position	Model Information	Attributes
YB1				
RH-3781			2010-2012 ZDX	
RH-3782			2010-2012 ZDX	
RH-3783			2010-2012 ZDX	
RH-3784			2010-2012 ZDX	
YD2				
C-3020			2007-2013 MDX	3.7 AWD, w/EDC, w/Advance & Sports Packages, w/Active Suspension Dampers
RH-3781			2007-2013 MDX	3.7 AWD
RH-3782			2007-2013 MDX	3.7 AWD
RH-3783			2007-2013 MDX	3.7 AWD
RH-3784			2007-2013 MDX	3.7 AWD

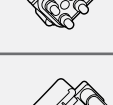
AUDI				
Part #	Product Type	Position	Model Information	Attributes
4G				
AS-3309			2013-2018 A7	1.8 TFSI, 2.0 TFSI/TFSI quattro, 2.8 FSI/FSI quattro, 3.0 TDI/TDI quattro
			2013-2018 S7	quattro
P-3483			2012-2018 A7	1.8 TFSI, 2.0 TFSI/TFSI quattro, 2.8 FSI/FSI quattro, 3.0 TDI/TDI quattro/TFSI quattro
			2013-2018 S7	quattro
4L				
A-2523			2007-2015 Q7	3.0 TDI quattro/TFSI quattro, 3.6 FSI quattro, 4.2 FSI quattro/TDI quattro, 6.0 TDI quattro
A-2571			2007-2015 Q7	3.0 TDI quattro/TFSI quattro, 3.6 FSI quattro, 4.2 FSI quattro/TDI quattro, 6.0 TDI quattro
A-2572			2007-2015 Q7	3.0 TDI quattro/TFSI quattro, 3.6 FSI quattro, 4.2 FSI quattro/TDI quattro, 6.0 TDI quattro
C-3419			2007-2015 Q7	3.0 TDI quattro/TFSI quattro, 3.6 FSI quattro, 4.2 FSI quattro/TDI quattro, 6.0 TDI quattro
P-2496			2007-2015 Q7	3.0 TDI quattro/TFSI quattro, 3.6 FSI quattro, 4.2 FSI quattro/TDI quattro, 6.0 TDI quattro
VB-3470			2007-2015 Q7	3.0 TDI quattro/TFSI quattro, 3.6 FSI quattro, 4.2 FSI quattro/TDI quattro, 6.0 TDI quattro
VB-3824			2007-2015 Q7	3.0 TDI quattro/TFSI quattro, 3.6 FSI quattro, 4.2 FSI quattro/TDI quattro, 6.0 TDI quattro
4M				
P-3473			2016-2021 Q7	2.0 TFSI quattro, 3.0 TDI e-tron quattro, TDI/TFSI quattro, 45/50 TDI Mild Hybrid quattro, 55 TFSI Mild Hybrid quattro, 55/60 TFSI e quattro, Van (3.0 45/50 TDI Mild Hybrid quattro, 3.0 TDI quattro)
			2019-2021 Q8	
			2020-2021 SQ7	quattro/TDI quattro, Van 4.0 TDI quattro
			2020-2021 SQ8	

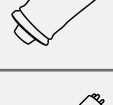

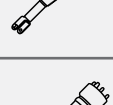





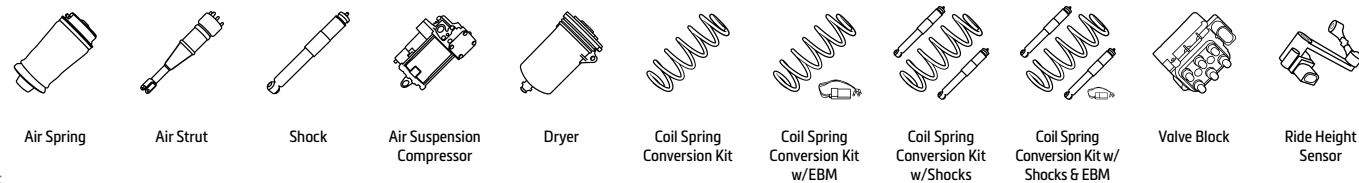

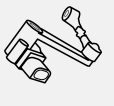

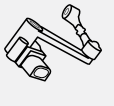

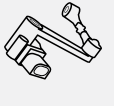

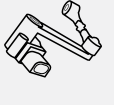





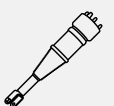

ENGINEERED TO RIDE, BUILT TO LAST.®

AUDI				
Part #	Product Type	Position	Model Information	Attributes
8R				
RH-3459			2009-2017 Q5	2.0 Hybrid quattro, 2.0 TDI/TDI quattro/TFSI Hybrid quattro/TFSI quattro, 3.0 TDI quattro/TFSI quattro, 3.2 FSI quattro, 35 TDI quattro, 40 TDI quattro, 45 TDI quattro/TFSI Mild Hybrid quattro, 50 TDI quattro, 55 TFSI e quattro
			2014-2017 SQ5	TDI quattro/TDI Mild Hybrid quattro, TFSI quattro
RH-3460			2009-2017 Q5	2.0 Hybrid quattro, 2.0 TDI/TDI quattro/TFSI Hybrid quattro/TFSI quattro, 3.0 TDI quattro/TFSI quattro, 3.2 FSI quattro, 35 TDI quattro, 40 TDI quattro, 45 TDI quattro/TFSI Mild Hybrid quattro, 50 TDI quattro, 55 TFSI e quattro
			2014-2017 SQ5	TDI quattro/TDI Mild Hybrid quattro, TFSI quattro
RH-3589			2009-2018 Q5	2.0 Hybrid quattro, 2.0 TDI/TDI quattro/TFSI Hybrid quattro/TFSI quattro, 3.0 TDI quattro/TFSI quattro, 3.2 FSI quattro, 35 TDI quattro, 40 TDI quattro, 45 TDI quattro/TFSI Mild Hybrid quattro, 50 TDI quattro, 55 TFSI e quattro
			2014-2017 SQ5	TDI quattro/TDI Mild Hybrid quattro, TFSI quattro
RH-3590			2009-2018 Q5	2.0 Hybrid quattro, 2.0 TDI/TDI quattro/TFSI Hybrid quattro/TFSI quattro, 3.0 TDI quattro/TFSI quattro, 3.2 FSI quattro, 35 TDI quattro, 40 TDI quattro, 45 TDI quattro/TFSI Mild Hybrid quattro, 50 TDI quattro, 55 TFSI e quattro
			2014-2017 SQ5	TDI quattro/TDI Mild Hybrid quattro, TFSI quattro
C5				
A-2133			2001-2005 Allroad Quattro	4B5, 4BH - 2.5 TDI quattro, 2.7 quattro/T quattro, 4.6 quattro/V8 quattro, S6 quattro
A-2731 (Gen. II)			2001-2005 Allroad Quattro	4B5, 4BH - 2.5 TDI quattro, 2.7 quattro/T quattro, 4.6 quattro/V8 quattro, S6 quattro
A-2869			2001-2005 Allroad Quattro	4BH - 2.5 TDI quattro, 2.7 quattro/T quattro, 4.2 V8 quattro
A-2885 (Gen. II)			2001-2005 Allroad Quattro	4BH - 2.5 TDI quattro, 2.7 quattro/T quattro, 4.2 V8 quattro
AS-3222			2001-2005 Allroad Quattro	4B2, 4B5, 4BH - 1.8, 1.8 T/T quattro, 1.9 TDI, 2.0, 2.4, 2.4 quattro, 2.5 TDI/TDI quattro, 2.7 quattro/T/T quattro, 2.8, 2.8 quattro, 3.0, 3.0 quattro, 3.6, 3.7 quattro, 4.2 quattro/V8 quattro, RS6 plus quattro/quattro, S6 quattro
AS-3223			2001-2005 Allroad Quattro	4B2, 4B5, 4BH - 1.8, 1.8 T/T quattro, 1.9 TDI, 2.0, 2.4, 2.4 quattro, 2.5 TDI/TDI quattro, 2.7 quattro/T/T quattro, 2.8, 2.8 quattro, 3.0, 3.0 quattro, 3.6, 3.7 quattro, 4.2 quattro/V8 quattro, RS6 plus quattro/quattro, S6 quattro

AUDI				
Part #	Product Type	Position	Model Information	Attributes
C5				
AS-3230 (Gen. II)			2001-2005 Allroad Quattro	4B2, 4B5, 4BH - 1.8, 1.8 T/T quattro, 1.9 TDI, 2.0, 2.4, 2.4 quattro, 2.5 TDI/TDI quattro, 2.7 quattro/T/T quattro, 2.8, 2.8 quattro, 3.0, 3.0 quattro, 3.6, 3.7 quattro, 4.2 quattro/V8 quattro, RS6 plus quattro/quattro, S6 quattro
AS-3231 (Gen. II)			2001-2005 Allroad Quattro	4B2, 4B5, 4BH - 1.8, 1.8 T/T quattro, 1.9 TDI, 2.0, 2.4, 2.4 quattro, 2.5 TDI/TDI quattro, 2.7 quattro/T/T quattro, 2.8, 2.8 quattro, 3.0, 3.0 quattro, 3.6, 3.7 quattro, 4.2 quattro/V8 quattro, RS6 plus quattro/quattro, S6 quattro
C-2718			2001-2005 Allroad Quattro	4BH - 2.5 TDI quattro, 2.7 quattro/T quattro, 4.2 V8 quattro
P-2134			2001-2005 Allroad Quattro	4BH - 2.5 TDI quattro, 2.7 quattro/T quattro, 4.2 quattro/V8 quattro, S6 quattro
SK-2779			2001-2005 Allroad Quattro	4BH - 2.5 TDI quattro, 2.7 quattro/T quattro, 4.2 V8 quattro
SK-2805			2001-2005 Allroad Quattro	4B5, 4BH - 1.8 T quattro, 2.4 quattro, 2.5 TDI quattro, 2.7 quattro/T quattro, 2.8 quattro, 3.0 quattro, 3.7 quattro, 4.2 quattro/V8 quattro, RS6 plus quattro/quattro, S6 quattro
VB-3265			2001-2005 Allroad Quattro	4B2, 4B5, 4BH - 1.9 TDI, 2.0, 2.4, 2.4 quattro, 2.5 TDI/TDI quattro, 2.7 quattro/T/T quattro, 2.8, 2.8 quattro, 3.0, 3.0 quattro, 3.6, 3.7 quattro, RS6 quattro, S6 quattro
VB-3831			2001-2005 Allroad Quattro	4B2, 4B5, 4BH - 1.9 TDI, 2.0, 2.4, 2.4 quattro, 2.5 TDI/TDI quattro, 2.7 quattro/T/T quattro, 2.8, 2.8 quattro, 3.0, 3.0 quattro, 3.6, 3.7 quattro, RS6 quattro, S6 quattro
C6				
A-2960			2005-2011 A6	4F2, 4F5, 4FH - 2.0 TDI/TFSI, 2.4, 2.4 quattro, 2.7 TDI/TDI quattro, 2.8 FSI/FSI quattro, 3.0, 3.0 quattro/TDI/TDI quattro/TFSI quattro, 3.2 FSI/FSI quattro, 4.2 FSI quattro/quattro, RS6 quattro, S6 quattro
			2007-2011 S6	
AS-3363			2005-2011 A6	4F2, 4F5, 4FH - 2.0 TDI/TFSI, 2.4, 2.4 quattro, 2.7 TDI/TDI quattro, 2.8 FSI/FSI quattro, 3.0, 3.0 quattro/TDI/TDI quattro/TFSI quattro, 3.2 FSI/FSI quattro, 4.2 FSI quattro/quattro, RS6 quattro, S6 quattro
			2007-2011 S6	
AS-3369			2005-2011 A6	4F2, 4F5, 4FH - 2.0 TDI/TFSI, 2.4, 2.4 quattro, 2.7 TDI/TDI quattro, 2.8 FSI/FSI quattro, 3.0, 3.0 quattro/TDI/TDI quattro/TFSI quattro, 3.2 FSI/FSI quattro, 4.2 FSI quattro/quattro, RS6 quattro, S6 quattro
			2007-2011 S6	



AUDI				
Part #	Product Type	Position	Model Information	Attributes
C6				
P-2984	 OES		2005-2011 A6 2007-2011 S6	4F2, 4F5, 4FH - 2.0 TDI/TFSI, 2.4, 2.4 quattro, 2.7 TDI/TDI quattro, 2.8 FSI/FSI quattro, 3.0, 3.0 quattro/TDI/TDI quattro/TFSI quattro, 3.2 FSI/FSI quattro, 4.2 FSI quattro/quattro, RS6 quattro, S6 quattro
RH-3703			2005-2011 A6 2007-2011 S6	4F2, 4F5, 4FH - 2.0 TDI/TFSI, 2.4, 2.4 quattro, 2.7 TDI/TDI quattro, 2.8 FSI/FSI quattro, 3.0, 3.0 quattro/TDI/TDI quattro/TFSI quattro, 3.2 FSI/FSI quattro, 4.2 FSI quattro/quattro, RS6 quattro, S6 quattro
RH-3704			2005-2011 A6 2007-2011 S6	4F2, 4F5, 4FH - 2.0 TDI/TFSI, 2.4, 2.4 quattro, 2.7 TDI/TDI quattro, 2.8 FSI/FSI quattro, 3.0, 3.0 quattro/TDI/TDI quattro/TFSI quattro, 3.2 FSI/FSI quattro, 4.2 FSI quattro/quattro, RS6 quattro, S6 quattro
RH-3705			2005-2011 A6 2007-2011 S6	4F2, 4F5, 4FH - 2.0 TDI/TFSI, 2.4, 2.4 quattro, 2.7 TDI/TDI quattro, 2.8 FSI/FSI quattro, 3.0, 3.0 quattro/TDI/TDI quattro/TFSI quattro, 3.2 FSI/FSI quattro, 4.2 FSI quattro/quattro, RS6 quattro, S6 quattro
RH-3706			2005-2011 A6 2007-2011 S6	4F2, 4F5, 4FH - 2.0 TDI/TFSI, 2.4, 2.4 quattro, 2.7 TDI/TDI quattro, 2.8 FSI/FSI quattro, 3.0, 3.0 quattro/TDI/TDI quattro/TFSI quattro, 3.2 FSI/FSI quattro, 4.2 FSI quattro/quattro, RS6 quattro, S6 quattro
VB-3265			2005-2011 A6 2007-2011 S6	4F2, 4F5, 4FH - 2.0 TDI/TFSI, 2.4, 2.4 quattro, 2.7 TDI/TDI quattro, 2.8 FSI/FSI quattro, 3.0, 3.0 quattro/TDI/TDI quattro/TFSI quattro, 3.2 FSI/FSI quattro, 4.2 FSI quattro/quattro, RS6 quattro, S6 quattro
VB-3831			2005-2011 A6 2007-2011 S6	4F2, 4F5, 4FH - 2.0 TDI/TFSI, 2.4, 2.4 quattro, 2.7 TDI/TDI quattro, 2.8 FSI/FSI quattro, 3.0, 3.0 quattro/TDI/TDI quattro/TFSI quattro, 3.2 FSI/FSI quattro, 4.2 FSI quattro/quattro, RS6 quattro, S6 quattro
C7				
A-3294			2012-2018 A6 2013-2018 S6 2013-2018 S7 2014-2018 RS7	4G2, 4G5, 4GA, 4GC, 4GD, 4GF - 1.8 TFSI, 2.0 TDI/TDI quattro/TFSI/TFSI hybrid/TFSI quattro, 2.8 FSI/FSI quattro, 3.0 TDI/TDI quattro/TFSI quattro, RS6/7 performance quattro/quattro, S6/7 quattro
A-3295			2012-2018 A6 2013-2018 S6 2013-2018 S7 2014-2018 RS7	4G2, 4GC - 1.8 TFSI, 2.0 TDI/TDI quattro/TFSI/TFSI hybrid/TFSI quattro, 2.8 FSI/FSI quattro, 3.0 TDI/TDI quattro/TFSI quattro, RS7 performance quattro/quattro, S6/7 quattro
AS-3309			2012-2018 A6 2013-2018 S6	4G2, 4G5, 4GC, 4GD - 1.8 TFSI, 2.0 TDI/TDI quattro/TFSI/TFSI quattro, 2.8 FSI/FSI quattro, 3.0 TDI/TDI quattro/TFSI quattro, RS6 quattro/performance quattro

AUDI				
Part #	Product Type	Position	Model Information	Attributes
C7				
AS-3312			2012-2018 A6 2012-2018 A7 2013-2018 S6 2013-2018 S7	4G2, 4G5, 4GA, 4GC, 4GD, 4GF - 1.8 TFSI, 2.0 TDI/TDI quattro/TFSI/TFSI hybrid/TFSI quattro, 2.8 FSI/FSI quattro, 3.0 TDI/TDI quattro/TFSI quattro, RS6/7 performance quattro/quattro, S6/7 quattro
P-3483	 OES		2012-2018 A6 2013-2018 S6 2014-2018 RS7	1.8 TFSI, 2.0 TDI/TDI quattro/TFSI/TFSI hybrid/TFSI quattro, 2.8 FSI/FSI quattro, 3.0 TDI/TDI quattro/TFSI quattro
RH-3587			2012-2018 A6 2012-2018 A7 2013-2018 S6 2013-2018 S7 2014-2018 RS7	4G2, 4G5, 4GA, 4GC, 4GD, 4GF - 1.8 TFSI, 2.0 TDI/TDI quattro/TFSI/TFSI hybrid/TFSI quattro, 2.8 FSI/FSI quattro, 3.0 TDI/TDI quattro/TFSI quattro, RS6/7 performance quattro/quattro, S6/7 quattro
RH-3588			2012-2018 A6 2012-2018 A7 2013-2018 S6 2013-2018 S7 2014-2018 RS7	4G2, 4G5, 4GA, 4GC, 4GD, 4GF - 1.8 TFSI, 2.0 TDI/TDI quattro/TFSI/TFSI hybrid/TFSI quattro, 2.8 FSI/FSI quattro, 3.0 TDI/TDI quattro/TFSI quattro, RS6/7 performance quattro/quattro, S6/7 quattro







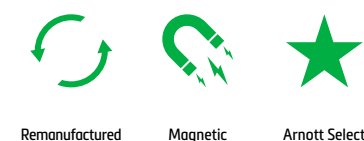
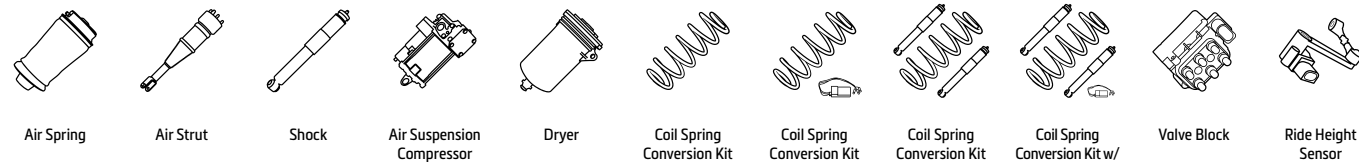



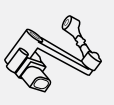

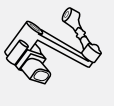

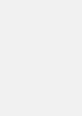

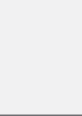







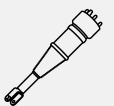



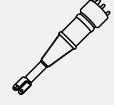

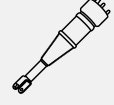

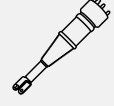



NEW RIDE HEIGHT SENSORS

- Ride height sensors for 09-18 Audi A6/S6, A7/S7, A8/S8, Q5, RS7 & SQ5
- Lab tested to 1 million cycles
- Road tested for function & fitment
- Direct fit for fast plug & play installation
- RH-3589 (rear right) & RH-3590 (rear left)







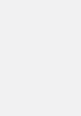

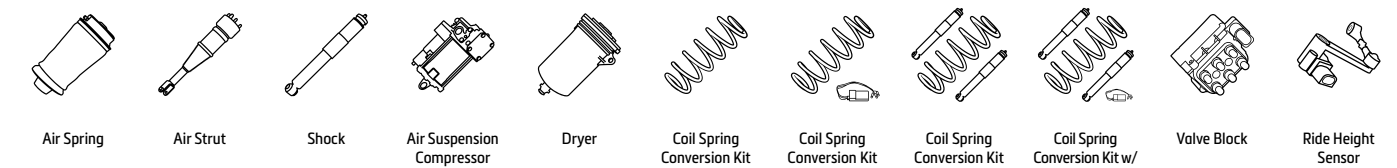

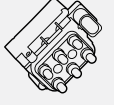
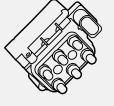



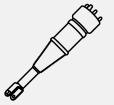

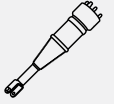

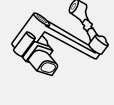

ENGINEERED TO RIDE, BUILT TO LAST.®

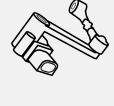
AUDI				
Part #	Product Type	Position	Model Information	Attributes
C7				
RH-3589			2012-2018 A6	4G2, 4G5, 4GA, 4GC, 4GD, 4GF - 1.8 TFSI, 2.0 TDI/TDI quattro/TFSI/TFSI hybrid/TFSI quattro, 2.8 FSI/FSI quattro, 3.0 TDI/TDI quattro/TFSI quattro, RS6/7 performance quattro/quattro, S6/7 quattro
			2012-2018 A7	
			2013-2018 S6	
			2013-2018 S7	
			2014-2018 RS7	
RH-3590			2012-2018 A6	4G2, 4G5, 4GA, 4GC, 4GD, 4GF - 1.8 TFSI, 2.0 TDI/TDI quattro/TFSI/TFSI hybrid/TFSI quattro, 2.8 FSI/FSI quattro, 3.0 TDI/TDI quattro/TFSI quattro, RS6/7 performance quattro/quattro, S6/7 quattro
			2012-2018 A7	
			2013-2018 S6	
			2013-2018 S7	
			2014-2018 RS7	
VB-3491			2012-2018 A6	4G2, 4GA, 4GC, 4GF - 1.8 TFSI, 2.0 TDI/TDI quattro/TFSI/TFSI hybrid/TFSI quattro, 2.8 FSI/FSI quattro, 3.0 TDI/TDI quattro/TFSI quattro, RS7 quattro/performance quattro
			2013-2018 S6	
			2014-2018 RS7	
VB-3832			2012-2018 A6	4G2, 4GC - 1.8 TFSI, 2.0 TDI/TDI quattro/TFSI/TFSI hybrid/TFSI quattro, 2.8 FSI/FSI quattro, 3.0 TDI/TDI quattro/TFSI quattro, RS7 performance quattro/quattro, S6/7 quattro
			2013-2018 S6	
			2013-2018 S7	
			2014-2018 RS7	
D3				
AS-2560			2004-2010 A8 Quattro	w/o Sport Suspension 4E2, 4E8 - 2.8 FSI, 3.0, 3.0 quattro/TDI quattro, 3.2 FSI/FSI quattro, 3.7 quattro, 4.0 TDI quattro, 4.2 FSI quattro/quattro/TDI quattro, 6.0 W12 quattro, S8 quattro
AS-2561			2004-2010 A8 Quattro	w/o Sport Suspension 4E2, 4E8 - 2.8 FSI, 3.0, 3.0 quattro/TDI quattro, 3.2 FSI/FSI quattro, 3.7 quattro, 4.0 TDI quattro, 4.2 FSI quattro/quattro/TDI quattro, 6.0 W12 quattro, S8 quattro
AS-2562			2004-2010 A8	w/Sport Suspension 4E2, 4E8 - 3.0, 3.0 quattro/TDI quattro, 3.2 FSI/FSI quattro, 3.7 quattro, 4.0 TDI quattro, 4.2 FSI quattro/quattro/TDI quattro, 6.0 W12 quattro, S8 quattro
			2007-2010 S8	w/Sport Suspension 4E2, 4E8 - 3.0, 3.0 quattro/TDI quattro, 3.2 FSI/FSI quattro, 3.7 quattro, 4.0 TDI quattro, 4.2 FSI quattro/quattro/TDI quattro, 6.0 W12 quattro, S8 quattro
AS-2563			2004-2010 A8	w/Sport Suspension 4E2, 4E8 - 3.0, 3.0 quattro/TDI quattro, 3.2 FSI/FSI quattro, 3.7 quattro, 4.0 TDI quattro, 4.2 FSI quattro/quattro/TDI quattro, 6.0 W12 quattro, S8 quattro
			2007-2010 S8	w/Sport Suspension 4E2, 4E8 - 3.0, 3.0 quattro/TDI quattro, 3.2 FSI/FSI quattro, 3.7 quattro, 4.0 TDI quattro, 4.2 FSI quattro/quattro/TDI quattro, 6.0 W12 quattro, S8 quattro
AS-2775			2004-2010 A8	w/o Sport Suspension 4E2, 4E8 - 2.8 FSI, 3.0, 3.0 quattro/TDI quattro, 3.2 FSI/FSI quattro, 3.7 quattro, 4.0 TDI quattro, 4.2 FSI quattro/quattro/TDI quattro, 6.0 W12 quattro, S8 quattro

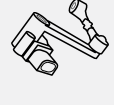
AUDI				
Part #	Product Type	Position	Model Information	Attributes
D3				
AS-2776			2004-2010 A8	w/o Sport Suspension 4E2, 4E8 - 2.8 FSI, 3.0, 3.0 quattro/TDI quattro, 3.2 FSI/FSI quattro, 3.7 quattro, 4.0 TDI quattro, 4.2 FSI quattro/quattro/TDI quattro, 6.0 W12 quattro, S8 quattro
AS-2777			2004-2010 A8	w/Sport Suspension 4E2, 4E8 - 3.0, 3.0 quattro/TDI quattro, 3.2 FSI/FSI quattro, 3.7 quattro, 4.0 TDI quattro, 4.2 FSI quattro/quattro/TDI quattro, 6.0 W12 quattro, S8 quattro
			2007-2010 S8	w/Sport Suspension 4E2, 4E8 - 3.0, 3.0 quattro/TDI quattro, 3.2 FSI/FSI quattro, 3.7 quattro, 4.0 TDI quattro, 4.2 FSI quattro/quattro/TDI quattro, 6.0 W12 quattro, S8 quattro
AS-2778			2004-2010 A8	w/Sport Suspension 4E2, 4E8 - 3.0, 3.0 quattro/TDI quattro, 3.2 FSI/FSI quattro, 3.7 quattro, 4.0 TDI quattro, 4.2 FSI quattro/quattro/TDI quattro, 6.0 W12 quattro, S8 quattro
			2007-2010 S8	w/Sport Suspension 4E2, 4E8 - 3.0, 3.0 quattro/TDI quattro, 3.2 FSI/FSI quattro, 3.7 quattro, 4.0 TDI quattro, 4.2 FSI quattro/quattro/TDI quattro, 6.0 W12 quattro, S8 quattro
AS-2958			2004-2010 A8	w/o Sport Suspension 4E2, 4E8, 4H2, 4H8, 4HC, 4HL - 2.8 FSI, 3.0, 3.0 quattro/TDI quattro, 3.2 FSI/FSI quattro, 3.7 quattro, 4.0 TDI quattro, 4.2 FSI quattro/quattro/TDI quattro, 6.0 W12 quattro, S8 quattro
AS-2959			2004-2010 A8	w/o Sport Suspension 4E2, 4E8, 4H2, 4H8, 4HC, 4HL - 2.8 FSI, 3.0, 3.0 quattro/TDI quattro, 3.2 FSI/FSI quattro, 3.7 quattro, 4.0 TDI quattro, 4.2 FSI quattro/quattro/TDI quattro, 6.0 W12 quattro, S8 quattro
AS-2965			2004-2010 A8	w/Sport Suspension 4E2, 4E8 - 3.0, 3.0 quattro/TDI quattro, 3.2 FSI/FSI quattro, 3.7 quattro, 4.0 TDI quattro, 4.2 FSI quattro/quattro/TDI quattro, 6.0 W12 quattro, S8 quattro
			2007-2010 S8	w/Sport Suspension 4E2, 4E8 - 3.0, 3.0 quattro/TDI quattro, 3.2 FSI/FSI quattro, 3.7 quattro, 4.0 TDI quattro, 4.2 FSI quattro/quattro/TDI quattro, 6.0 W12 quattro, S8 quattro
AS-2966			2004-2010 A8	w/Sport Suspension 4E2, 4E8 - 3.0, 3.0 quattro/TDI quattro, 3.2 FSI/FSI quattro, 3.7 quattro, 4.0 TDI quattro, 4.2 FSI quattro/quattro/TDI quattro, 6.0 W12 quattro, S8 quattro
			2007-2010 S8	w/Sport Suspension 4E2, 4E8 - 3.0, 3.0 quattro/TDI quattro, 3.2 FSI/FSI quattro, 3.7 quattro, 4.0 TDI quattro, 4.2 FSI quattro/quattro/TDI quattro, 6.0 W12 quattro, S8 quattro
AS-3030			2004-2010 A8	w/o Sport Suspension 2.8 FSI, 3.0, 3.0 quattro, 3.0 TDI quattro, 3.2 FSI, 3.2 FSI quattro, 3.7 quattro, 4.0 TDI quattro, 4.2 FSI quattro, 4.2 quattro, 4.2 TDI quattro, 6.0 W12 quattro
AS-3031			2004-2010 A8	w/o Sport Suspension 2.8 FSI, 3.0, 3.0 quattro, 3.0 TDI quattro, 3.2 FSI, 3.2 FSI quattro, 3.7 quattro, 4.0 TDI quattro, 4.2 FSI quattro, 4.2 quattro, 4.2 TDI quattro, 6.0 W12 quattro
P-2539			2004-2010 A8 Quattro	w/ & w/o Sport Suspension, V8 Gas Engine Only 4E2, 4E8 - 2.8 FSI, 3.0, 3.0 quattro, 3.2 FSI/FSI quattro, 3.7 quattro, 4.2 FSI quattro/quattro, 6.0 W12 quattro, S8 quattro
			2007-2010 S8	w/ & w/o Sport Suspension, V8 Gas Engine Only 4E2, 4E8 - 2.8 FSI, 3.0, 3.0 quattro, 3.2 FSI/FSI quattro, 3.7 quattro, 4.2 FSI quattro/quattro, 6.0 W12 quattro, S8 quattro

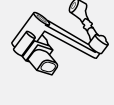

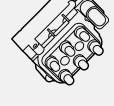
AUDI				
Part #	Product Type	Position	Model Information	Attributes
D3				
P-2599	 OES		2004-2010 A8 Quattro	w/ & w/o Sport Suspension, Diesel Engine & W12 Gas Engine Only 3.0 TDI quattro, 4.0 TDI quattro, 4.2 TDI quattro
VB-3265			2004-2010 A8	w/ & w/o Sport Suspension 4E2, 4E8 - 2.8 FSI, 3.0, 3.0 quattro/TDI quattro, 3.2 FSI/FSI quattro, 3.7 quattro, 4.0 TDI quattro, 4.2 FSI quattro/quattro/TDI quattro, 6.0 W12 quattro, S8 quattro
			2007-2010 S8	w/Sport Suspension 4E2, 4E8 - 2.8 FSI, 3.0, 3.0 quattro/TDI quattro, 3.2 FSI/FSI quattro, 3.7 quattro, 4.0 TDI quattro, 4.2 FSI quattro/quattro/TDI quattro, 6.0 W12 quattro, S8 quattro
VB-3831			2004-2010 A8	w/ & w/o Sport Suspension 4E2, 4E8 - 2.8 FSI, 3.0, 3.0 quattro/TDI quattro, 3.2 FSI/FSI quattro, 3.7 quattro, 4.0 TDI quattro, 4.2 FSI quattro/quattro/TDI quattro, 6.0 W12 quattro, S8 quattro
			2007-2009 S8	w/Sport Suspension 4E2, 4E8 - 2.8 FSI, 3.0, 3.0 quattro/TDI quattro, 3.2 FSI/FSI quattro, 3.7 quattro, 4.0 TDI quattro, 4.2 FSI quattro/quattro/TDI quattro, 6.0 W12 quattro, S8 quattro
D4				
AS-2864			2011-2018 A8 Quattro	w/o Sport Suspension 4H - 2.0 TFSI hybrid, 2.5 TFSI, 3.0 TDI, 3.0 TDI quattro, 3.0 TFSI quattro, 4.0 TFSI quattro, 4.2 FSI quattro, 4.2 TDI quattro, 6.3 W12 quattro, S8 plus quattro, S8 quattro
AS-2865			2011-2018 A8 Quattro	w/Sport Suspension 4H - 2.0 TFSI hybrid, 2.5 TFSI, 3.0 TDI, 3.0 TDI quattro, 3.0 TFSI quattro, 4.0 TFSI quattro, 4.2 FSI quattro, 4.2 TDI quattro, 6.3 W12 quattro, S8 plus quattro, S8 quattro
			2013-2018 S8	w/Sport Suspension 4H - 2.0 TFSI hybrid, 2.5 TFSI, 3.0 TDI, 3.0 TDI quattro, 3.0 TFSI quattro, 4.0 TFSI quattro, 4.2 FSI quattro, 4.2 TDI quattro, 6.3 W12 quattro, S8 plus quattro, S8 quattro
AS-3121			2011-2018 A8	w/o Sport Suspension 4H2, 4H8, 4HC, 4HL - 2.0 TFSI Hybrid, 2.5 TFSI, 3.0 TDI/TDI quattro/TFSI quattro, 4.0 TFSI quattro, 4.2 TDI quattro, 6.3 W12 quattro
AS-3123			2011-2018 A8	w/o Sport Suspension 4H2, 4H8, 4HC, 4HL - 2.0 TFSI Hybrid, 2.5 TFSI, 3.0 TDI/TDI quattro/TFSI quattro, 4.0 TFSI quattro, 4.2 TDI quattro, 6.3 W12 quattro

AUDI				
Part #	Product Type	Position	Model Information	Attributes
D4				
P-2986	 OES		2011-2018 A8 Quattro	w/ & w/o Sport Suspension 4H - 2.0 TFSI hybrid, 2.5 TFSI, 3.0 TDI, 3.0 TDI quattro, 3.0 TFSI quattro, 4.0 TFSI quattro, 4.2 FSI quattro, 4.2 TDI quattro, 6.3 W12 quattro, S8 plus quattro, S8 quattro
			2013-2018 S8 Quattro	w/Sport Suspension 4H - 2.0 TFSI hybrid, 2.5 TFSI, 3.0 TDI, 3.0 TDI quattro, 3.0 TFSI quattro, 4.0 TFSI quattro, 4.2 FSI quattro, 4.2 TDI quattro, 6.3 W12 quattro, S8 plus quattro, S8 quattro
RH-3587			2011-2018 A8	w/ & w/o Sport Suspension 4H - 2.0 TFSI hybrid, 2.5 TFSI, 3.0 TDI, 3.0 TDI quattro, 3.0 TFSI quattro, 4.0 TFSI quattro, 4.2 FSI quattro, 4.2 TDI quattro, 6.3 W12 quattro, S8 plus quattro, S8 quattro
			2013-2018 S8	w/Sport Suspension 4H - 2.0 TFSI hybrid, 2.5 TFSI, 3.0 TDI, 3.0 TDI quattro, 3.0 TFSI quattro, 4.0 TFSI quattro, 4.2 FSI quattro, 4.2 TDI quattro, 6.3 W12 quattro, S8 plus quattro, S8 quattro
RH-3588			2011-2018 A8	w/ & w/o Sport Suspension 4H - 2.0 TFSI hybrid, 2.5 TFSI, 3.0 TDI, 3.0 TDI quattro, 3.0 TFSI quattro, 4.0 TFSI quattro, 4.2 FSI quattro, 4.2 TDI quattro, 6.3 W12 quattro, S8 plus quattro, S8 quattro
			2013-2018 S8	w/Sport Suspension 4H - 2.0 TFSI hybrid, 2.5 TFSI, 3.0 TDI, 3.0 TDI quattro, 3.0 TFSI quattro, 4.0 TFSI quattro, 4.2 FSI quattro, 4.2 TDI quattro, 6.3 W12 quattro, S8 plus quattro, S8 quattro
RH-3589			2011-2018 A8	w/ & w/o Sport Suspension 4H - 2.0 TFSI hybrid, 2.5 TFSI, 3.0 TDI, 3.0 TDI quattro, 3.0 TFSI quattro, 4.0 TFSI quattro, 4.2 FSI quattro, 4.2 TDI quattro, 6.3 W12 quattro, S8 plus quattro, S8 quattro
			2013-2018 S8	w/Sport Suspension 4H - 2.0 TFSI hybrid, 2.5 TFSI, 3.0 TDI, 3.0 TDI quattro, 3.0 TFSI quattro, 4.0 TFSI quattro, 4.2 FSI quattro, 4.2 TDI quattro, 6.3 W12 quattro, S8 plus quattro, S8 quattro
RH-3590			2011-2018 A8	w/ & w/o Sport Suspension 4H - 2.0 TFSI hybrid, 2.5 TFSI, 3.0 TDI, 3.0 TDI quattro, 3.0 TFSI quattro, 4.0 TFSI quattro, 4.2 FSI quattro, 4.2 TDI quattro, 6.3 W12 quattro, S8 plus quattro, S8 quattro
			2013-2018 S8	w/Sport Suspension 4H - 2.0 TFSI hybrid, 2.5 TFSI, 3.0 TDI, 3.0 TDI quattro, 3.0 TFSI quattro, 4.0 TFSI quattro, 4.2 FSI quattro, 4.2 TDI quattro, 6.3 W12 quattro, S8 plus quattro, S8 quattro
VB-3491			2011-2018 A8	w/ & w/o Sport Suspension 4H - 2.0 TFSI hybrid, 2.5 TFSI, 3.0 TDI, 3.0 TDI quattro, 3.0 TFSI quattro, 4.0 TFSI quattro, 4.2 FSI quattro, 4.2 TDI quattro, 6.3 W12 quattro, S8 plus quattro, S8 quattro
			2013-2018 S8	w/Sport Suspension 4H - 2.0 TFSI hybrid, 2.5 TFSI, 3.0 TDI, 3.0 TDI quattro, 3.0 TFSI quattro, 4.0 TFSI quattro, 4.2 FSI quattro, 4.2 TDI quattro, 6.3 W12 quattro, S8 plus quattro, S8 quattro
VB-3832			2011-2018 A8	w/ & w/o Sport Suspension 4H - 2.0 TFSI hybrid, 2.5 TFSI, 3.0 TDI, 3.0 TDI quattro, 3.0 TFSI quattro, 4.0 TFSI quattro, 4.2 FSI quattro, 4.2 TDI quattro, 6.3 W12 quattro, S8 plus quattro, S8 quattro
			2013-2018 S8	w/Sport Suspension 4H - 2.0 TFSI hybrid, 2.5 TFSI, 3.0 TDI, 3.0 TDI quattro, 3.0 TFSI quattro, 4.0 TFSI quattro, 4.2 FSI quattro, 4.2 TDI quattro, 6.3 W12 quattro, S8 plus quattro, S8 quattro
FY				
P-3474	 OES		2018-2021 Q5	2.0 TDI/TDI quattro/TFSI quattro, 3.0 TDI quattro, 30/35 Mild Hybrid, 35 TDI quattro, 40 TDI quattro/Mild Hybrid quattro, 45 TDI quattro/TFSI Mild Hybrid quattro, 50 TDI quattro/TFSI e quattro, 55 TFSI e quattro
			2018-2021 SQ5	TDI Mild Hybrid quattro, TFSI quattro

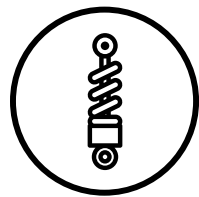

Arnott engineers strive to improve upon the original equipment part by using Tier 1 components such as name brand air sleeves, VOSS air line fittings, longer lasting seals, crimping rings and more.

Remanufactured with OE Components

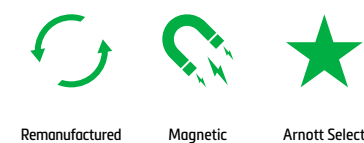
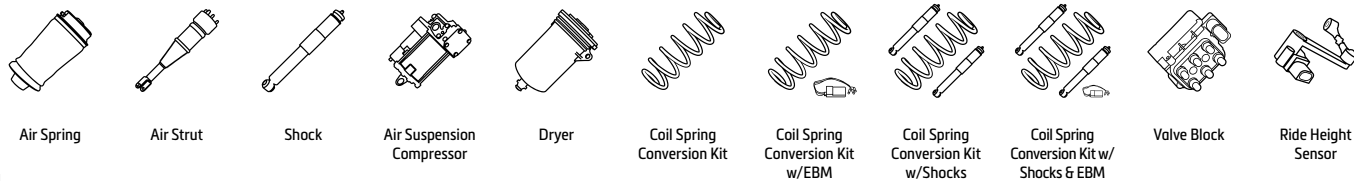







ENGINEERED TO RIDE, BUILT TO LAST.®

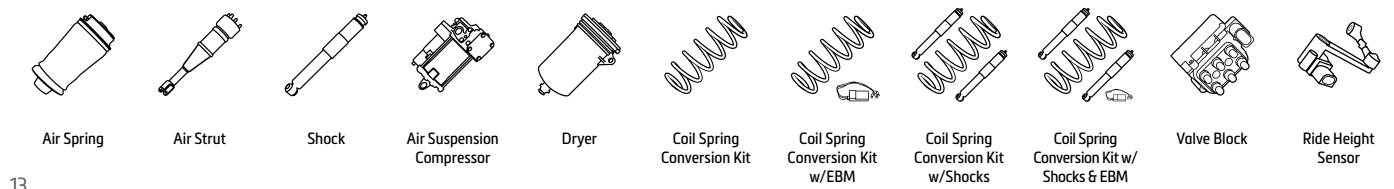



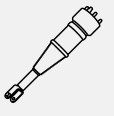

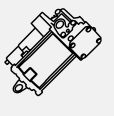



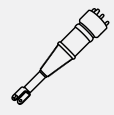

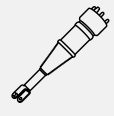

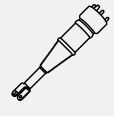
BENTLEY				
Part #	Product Type	Position	Model Information	Attributes
D1				
AS-2580			2003-2019 Continental GT	3W_ - 4.0, 4.0 Flex/Flex AWD, 6.0, 6.0 AWD/CSISR/Flex/Flex AWD
			2006-2019 Continental Flying Spur	3W_ - 6.0, 6.0 Flex
AS-2581			2003-2019 Continental GT	3W_ - 4.0, 4.0 Flex/Flex AWD, 6.0, 6.0 AWD/CSISR/Flex/Flex AWD
			2006-2019 Continental Flying Spur	3W_ - 6.0, 6.0 Flex
AS-2892			2003-2019 Continental GT	3W_ - 4.0, 4.0 Flex/Flex AWD, 6.0, 6.0 AWD/CSISR/Flex/Flex AWD
			2006-2019 Continental Flying Spur	3W_ - 6.0, 6.0 Flex
AS-2893			2003-2019 Continental GT	3W_ - 4.0, 4.0 Flex/Flex AWD, 6.0, 6.0 AWD/CSISR/Flex/Flex AWD
			2006-2019 Continental Flying Spur	3W_ - 6.0, 6.0 Flex
AS-2968			2003-2019 Continental GT	3W_ - 4.0, 4.0 Flex/Flex AWD, 6.0, 6.0 AWD/CSISR/Flex/Flex AWD
			2006-2019 Continental Flying Spur	3W_ - 6.0, 6.0 Flex
AS-2969			2003-2019 Continental GT	3W_ - 4.0, 4.0 Flex/Flex AWD, 6.0, 6.0 AWD/CSISR/Flex/Flex AWD
			2006-2019 Continental Flying Spur	3W_ - 6.0, 6.0 Flex
AS-3127			2003-2019 Continental GT	3W_ - 4.0, 4.0 Flex/GT, 6.0, 6.0 AWD/Flex/Supersports AWD
			2006-2019 Continental Flying Spur	3W_ - 6.0, 6.0 Flex
AS-3128			2003-2019 Continental GT	3W_ - 4.0, 4.0 Flex/GT, 6.0, 6.0 AWD/Flex/Supersports AWD
			2006-2019 Continental Flying Spur	3W_ - 6.0, 6.0 Flex
AS-3129			2003-2019 Continental GT	3W_ - 4.0, 4.0 Flex/GT, 6.0, 6.0 AWD/Flex/Supersports AWD
			2006-2019 Continental Flying Spur	3W_ - 6.0, 6.0 Flex
AS-3130			2003-2019 Continental GT	3W_ - 4.0, 4.0 Flex/GT, 6.0, 6.0 AWD/Flex/Supersports AWD
			2006-2019 Continental Flying Spur	3W_ - 6.0, 6.0 Flex

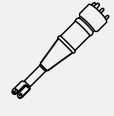
BENTLEY				
Part #	Product Type	Position	Model Information	Attributes
D1				
P-2740			2003-2019 Continental GT	3W_ - 4.0, 4.0 Flex/Flex AWD, 6.0, 6.0 AWD/CSISR/Flex/Flex AWD
			2006-2019 Continental Flying Spur	3W_ - 6.0, 6.0 Flex
F4				
P-3473			2014-2021 Bentayga	

BMW				
Part #	Product Type	Position	Model Information	Attributes
E39				
A-2737			1993-2003 5 Series	Wagon Only, w/Auto-Leveling
				520 d/i, 523 i, 525 d/i/tds, 528 i, 530 d/i, 540 i
A-2738			1993-2003 5 Series	Wagon Only, w/Auto-Leveling
				520 d/i, 523 i, 525 d/i/tds, 528 i, 530 d/i, 540 i
P-2469			1999-2003 5 Series	Wagon Only, w/Auto-Leveling, w/Rear Air Suspension Only
				520 d/i, 523 i, 525 d/i/tds, 528 i, 530 d/i, 540 i
E53				
A-2501			2000-2006 X5	w/Auto-Leveling, w/o Sport Suspension
				3.0 d, 4.4 i, 4.6 is, 4.8 is
A-2502			2000-2006 X5	w/Auto-Leveling, w/o Sport Suspension
				3.0 d, 4.4 i, 4.6 is, 4.8 is
A-2503			2000-2006 X5	w/Auto-Leveling, w/Sport Suspension
				3.0 d, 4.4 i, 4.6 is, 4.8 is
A-2504			2000-2006 X5	w/Auto-Leveling, w/Sport Suspension
				3.0 d, 4.4 i, 4.6 is, 4.8 is
A-2861			2000-2006 X5	w/4-Corner Air Leveling, w/ & w/o Sport Suspension
				3.0 d, 4.4 i, 4.6 is, 4.8 is

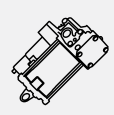

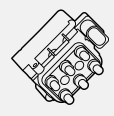



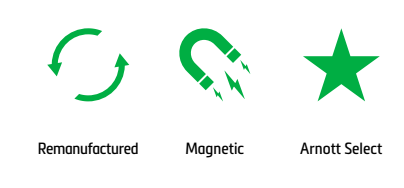
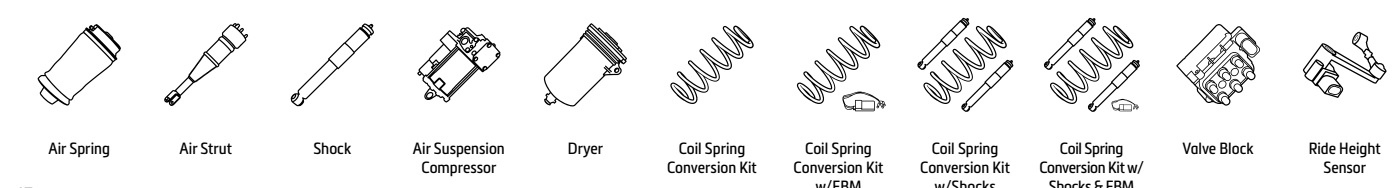





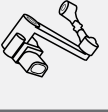

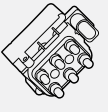
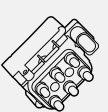



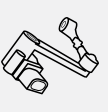

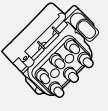
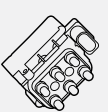





BMW				
Part #	Product Type	Position	Model Information	Attributes
E53				
A-2862			2000-2006 X5	w/4-Corner Air Leveling, w/ & w/o Sport Suspension 3.0 d, 4.4 i, 4.6 is, 4.8 is
AS-2764			2000-2006 X5	w/4-Corner Air Leveling, w/ & w/o Sport Suspension 3.0 d, 4.4 i, 4.6 is, 4.8 is
AS-2765			2000-2006 X5	w/4-Corner Air Leveling, w/ & w/o Sport Suspension 3.0 d, 4.4 i, 4.6 is, 4.8 is
C-2664			2000-2006 X5	w/ & w/o Sport Suspension 3.0 d, 4.4 i, 4.6 is, 4.8 is
P-2469	 OES		2000-2006 X5	w/Auto-Leveling, w/ & w/o Sport Suspension 3.0 d, 4.4 i, 4.6 is, 4.8 is
P-2494	 OES		2000-2006 X5	w/4-Corner Air Leveling, w/ & w/o Sport Suspension 3.0 d, 4.4 i, 4.6 is, 4.8 is
E61				
A-2755			2004-2010 5 Series	Wagon Only, w/Auto-Leveling 520 d/i, 523 i, 525 d/d xDrive/i/i xDrive/xd/xi, 530 d/d xDrive/i/i xDrive/xd/xi, 535 d, 545 i, 550 i
P-3220			2004-2010 5 Series	Wagon Only, w/Auto-Leveling 520 d/i, 523 i, 525 d/d xDrive/i/i xDrive/xd/xi, 530 d/d xDrive/i/i xDrive/xd/xi, 535 d, 545 i, 550 i
P-3729	 OES		2004-2010 5 Series	Wagon Only, w/Auto-Leveling 520 d/i, 523 i, 525 d/d xDrive/i/i xDrive/xd/xi, 530 d/d xDrive/i/i xDrive/xd/xi, 535 d, 545 i, 550 i
VB-2897			2004-2010 5 Series	Wagon Only, w/Auto-Leveling 520 d/i, 523 i, 525 d/d xDrive/i/i xDrive/xd/xi, 530 d/d xDrive/i/i xDrive/xd/xi, 535 d, 545 i, 550 i

BMW				
Part #	Product Type	Position	Model Information	Attributes
E65/66				
AS-2978			2002-2008 7 Series	w/EDC 730 d/i/Li/Ld, 735 i/Li, 740 d/i/Li, 745 d/i/Li, 750 i/Li, 760 i/Li
AS-2979			2002-2008 7 Series	w/EDC 730 d/i/Li/Ld, 735 i/Li, 740 d/i/Li, 745 d/i/Li, 750 i/Li, 760 i/Li
AS-2980			2002-2008 7 Series	w/o EDC 730 d/i/Li/Ld, 735 i/Li, 740 d/i/Li, 745 d/i/Li, 750 i/Li, 760 i/Li
AS-2981			2002-2008 7 Series	w/o EDC 730 d/i/Li/Ld, 735 i/Li, 740 d/i/Li, 745 d/i/Li, 750 i/Li, 760 i/Li
P-2469	 OES		2002-2008 7 Series	w/ & w/o EDC 730 d/i/Li/Ld, 735 i/Li, 740 d/i/Li, 745 d/i/Li, 750 i/Li, 760 i/Li
E70/71				
A-2642			2007-2013 X5 2008-2014 X6	w/Adaptive Drive, Comfort or Sport Suspension 3.0 d/sd/si, 4.8 i xDrive, M, M 50 d, xDrive (30 d/i, 35 d/i, 40 d/i, 48 i, 50 i) w/Adaptive Drive, Comfort or Sport Suspension ActiveHybrid, Active Hybrid xDrive, M, M 50 d, xDrive (30 d, 35 d/i, 40 d, 50 i)
P-3221			2007-2013 X5 2008-2014 X6	3.0 d/sd/si, 4.8 i xDrive, M, M 50 d, xDrive (30 d/i, 35 d/i, 40 d/i, 48 i, 50 i) ActiveHybrid, Active Hybrid xDrive, M, M 50 d, xDrive (30 d, 35 d/i, 40 d, 50 i)
P-3728	 OES		2007-2013 X5 2008-2014 X6	3.0 d/sd/si, 4.8 i xDrive, M, M 50 d, xDrive (30 d/i, 35 d/i, 40 d/i, 48 i, 50 i) ActiveHybrid, Active Hybrid xDrive, M, M 50 d, xDrive (30 d, 35 d/i, 40 d, 50 i)
VB-2898			2007-2013 X5 2008-2014 X6	3.0 d/sd/si, 4.8 i xDrive, M, M 50 d, xDrive (30 d/i, 35 d/i, 40 d, 48 i, 50 i) M, M 50 d, xDrive (30 d, 35 d/i, 40 d, 50 i)
F01/02/04				
AS-2823			2009-2015 7 Series	w/FlexRay Technology 730 d/d xDrive/i/Li, 740 d/d xDrive/i/Li/Li xDrive, 750 d xDrive/i/i xDrive, 760 i, Active Hybrid

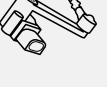

ENGINEERED TO RIDE, BUILT TO LAST.®

BMW				
Part #	Product Type	Position	Model Information	Attributes
F01/02/04				
AS-2824			2009-2015 7 Series	w/FlexRay Technology 730 d/d xDrive/i/Li, 740 d/d xDrive/i/Li/Li xDrive, 750 d xDrive/i/i xDrive, 760 i, Active Hybrid
P-2985	 OES		2009-2015 7 Series	730 d/d xDrive/i/Li, 740 d/d xDrive/i/Li/Li xDrive, 750 d xDrive/i/i xDrive, 760 i, Active Hybrid
RH-3718			2009-2015 7 Series	730 d/d xDrive/i/Li, 740 d/d xDrive/i/Li/Li xDrive, 750 d xDrive/i/i xDrive, 760 i, Active Hybrid
VB-3502			2009-2015 7 Series	730 d/d xDrive/i/Li, 740 d/d xDrive/i/Li/Li xDrive, 750 d xDrive/i/i xDrive, 760 i, Active Hybrid
VB-3787			2009-2015 7 Series	730 d/d xDrive/i/Li, 740 d/d xDrive/i/Li/Li xDrive, 750 d xDrive/i/i xDrive, 760 i, Active Hybrid
F07/11				
A-2780			2011-2017 5 Series GT 2011-2017 5 Series Wagon	w/Auto-Leveling, AWD & RWD 520 d, 528 i, 530 d/d xDrive, 535 d/d xDrive/i/i xDrive, 550 i/i xDrive w/Auto-Leveling, AWD & RWD 520 d, 528 i, 530 d/d xDrive, 535 d/d xDrive/i/i xDrive, 550 i/i xDrive
P-2985	 OES		2011-2017 5 Series GT 2011-2017 5 Series Wagon	w/Auto-Leveling, AWD & RWD 520 d, 528 i, 530 d/d xDrive, 535 d/d xDrive/i/i xDrive, 550 i/i xDrive w/Auto-Leveling, AWD & RWD 520 d, 528 i, 530 d/d xDrive, 535 d/d xDrive/i/i xDrive, 550 i/i xDrive
RH-3718			2011-2017 5 Series GT 2011-2017 5 Series Wagon	w/Auto-Leveling, AWD & RWD 520 d, 528 i, 530 d/d xDrive, 535 d/d xDrive/i/i xDrive, 550 i/i xDrive w/Auto-Leveling, AWD & RWD 520 d, 528 i, 530 d/d xDrive, 535 d/d xDrive/i/i xDrive, 550 i/i xDrive
VB-3502			2011-2017 5 Series GT	w/Auto-Leveling, AWD & RWD 520 d, 528 i, 530 d/d xDrive, 535 d/d xDrive/i/i xDrive, 550 i/i xDrive
VB-3787			2011-2017 5 Series GT	w/Auto-Leveling, AWD & RWD 520 d, 528 i, 530 d/d xDrive, 535 d/d xDrive/i/i xDrive, 550 i/i xDrive









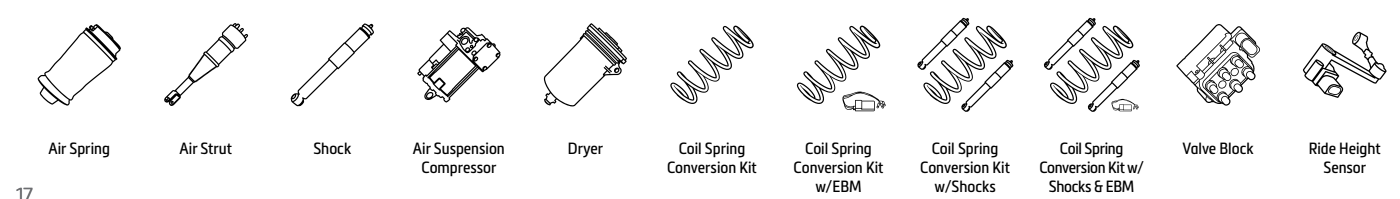





BMW				
Part #	Product Type	Position	Model Information	Attributes
F15/16				
A-2642			2014-2018 X5 2015-2019 X6	w/Adaptive Drive, Comfort or Sport Suspension M, M 50 d, sDrive 25 d, xDrive (25 d, 30 d, 35 i, 40 d/e, 50 i) w/Adaptive Drive, Comfort or Sport Suspension M, M 50 d, xDrive (30 d, 35 i, 40 d, 50 i)
P-3279	 OES		2014-2018 X5 2015-2019 X6	w/Adaptive Drive, Comfort or Sport Suspension M, M 50 d, sDrive 25 d, xDrive (25 d, 30 d, 35 i, 40 d, 40e, 50 i) w/Adaptive Drive, Comfort or Sport Suspension M, M 50 d, xDrive (30 d, 35 i, 40 d, 50 i)
G11/12				
AS-3370			2016-2018 7 Series	w/RWD, Short Wheelbase & Long Wheelbase 725 d/Ld, 730 d/Ld Mild-Hybrid/i/Li, 740 e/Le/i/Li, 745 e/Le Plug-in-Hybrid, 750 i/Li
AS-3371			2016-2018 7 Series	w/RWD, Short Wheelbase & Long Wheelbase 725 d/Ld, 730 d/Ld Mild-Hybrid/i/Li, 740 e/Le/i/Li, 745 e/Le Plug-in-Hybrid, 750 i/Li
AS-3372			2016-2018 7 Series	w/AWD, Short Wheelbase & Long Wheelbase 730 d Mild-Hybrid xDrive/d/Ld Mild-Hybrid xDrive/Ld xDrive, 740 Li xDrive/d/Ld Mild-Hybrid xDrive/Ld xDrive, 745 Le Plug-in-Hybrid xDrive, 750 d/Ld xDrive/i/Li xDrive
AS-3373			2016-2018 7 Series	w/AWD, Short Wheelbase & Long Wheelbase 730 d Mild-Hybrid xDrive/d/Ld Mild-Hybrid xDrive/Ld xDrive, 740 Li xDrive/d/Ld Mild-Hybrid xDrive/Ld xDrive, 745 Le Plug-in-Hybrid xDrive, 750 d/Ld xDrive/i/Li xDrive
P-3471	 OES		2016-2020 7 Series	Short Wheelbase & Long Wheelbase 725 d/Ld, 730 d/d Mild-Hybrid xDrive/Ld Mild-Hybrid/Ld Mild-Hybrid xDrive/Ld xDrive/i/Li, 740 Le xDrive/Li xDrive/d/Ld Mild-Hybrid xDrive/Ld xDrive/e/Le/i/Li, 745 Le Plug-in-Hybrid xDrive/e/Le Plug-in-Hybrid, 750 d/Ld xDrive/i/Li xDrive, M 760 Li xDrive/760 i/Li xDrive
RH-3718			2016-2021 7 Series	Short Wheelbase & Long Wheelbase 725 d/Ld, 730 d/d Mild-Hybrid xDrive/Ld Mild-Hybrid/Ld Mild-Hybrid xDrive/Ld xDrive/i/Li, 740 Le xDrive/Li xDrive/d/Ld Mild-Hybrid xDrive/Ld xDrive/e/Le/i/Li, 745 Le Plug-in-Hybrid xDrive/e/Le Plug-in-Hybrid, 750 d/Ld xDrive/i/Li xDrive, M 760 Li xDrive/760 i/Li xDrive

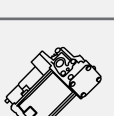
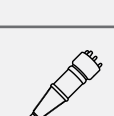

Road Tested

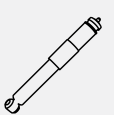
From Audi to Porsche, Range Rover to BMW and Mercedes, Arnott has more than 40 test vehicles to ensure that the products they engineer provide the luxury ride and durability that owners expect.

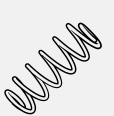

BUICK				
Part #	Product Type	Position	Model Information	Attributes
F55				
AS-2950			2006-2011 Lucerne	w/MagneRide, w/Sport Suspension
MR-3446			2006-2011 Lucerne	w/MagneRide
MR-3447			2006-2011 Lucerne	w/MagneRide
MR-3448			2006-2011 Lucerne	w/MagneRide
P-2982			2006-2011 Lucerne	
SK-2952			2006-2011 Lucerne	w/MagneRide, w/Sport Suspension
G Platform				
AS-2190 (Sold in Pairs)			1995-1999 Riviera	
			1997-2005 Park Avenue	3.8 Supercharged
			2000-2005 LeSabre	3.8
SK-2189 (Sold in Pairs)			2000-2005 LeSabre	3.8
GMT360				
A-2610 (Gen. II)			2004-2007 Rainier	
C-2137			2004-2007 Rainier	

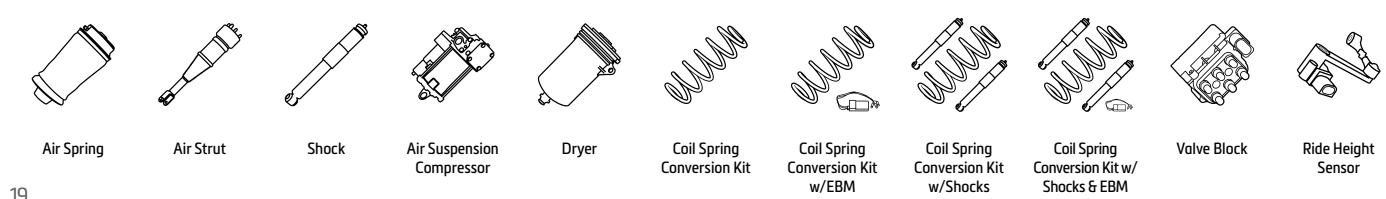

AIR SUSPENSION BASICS





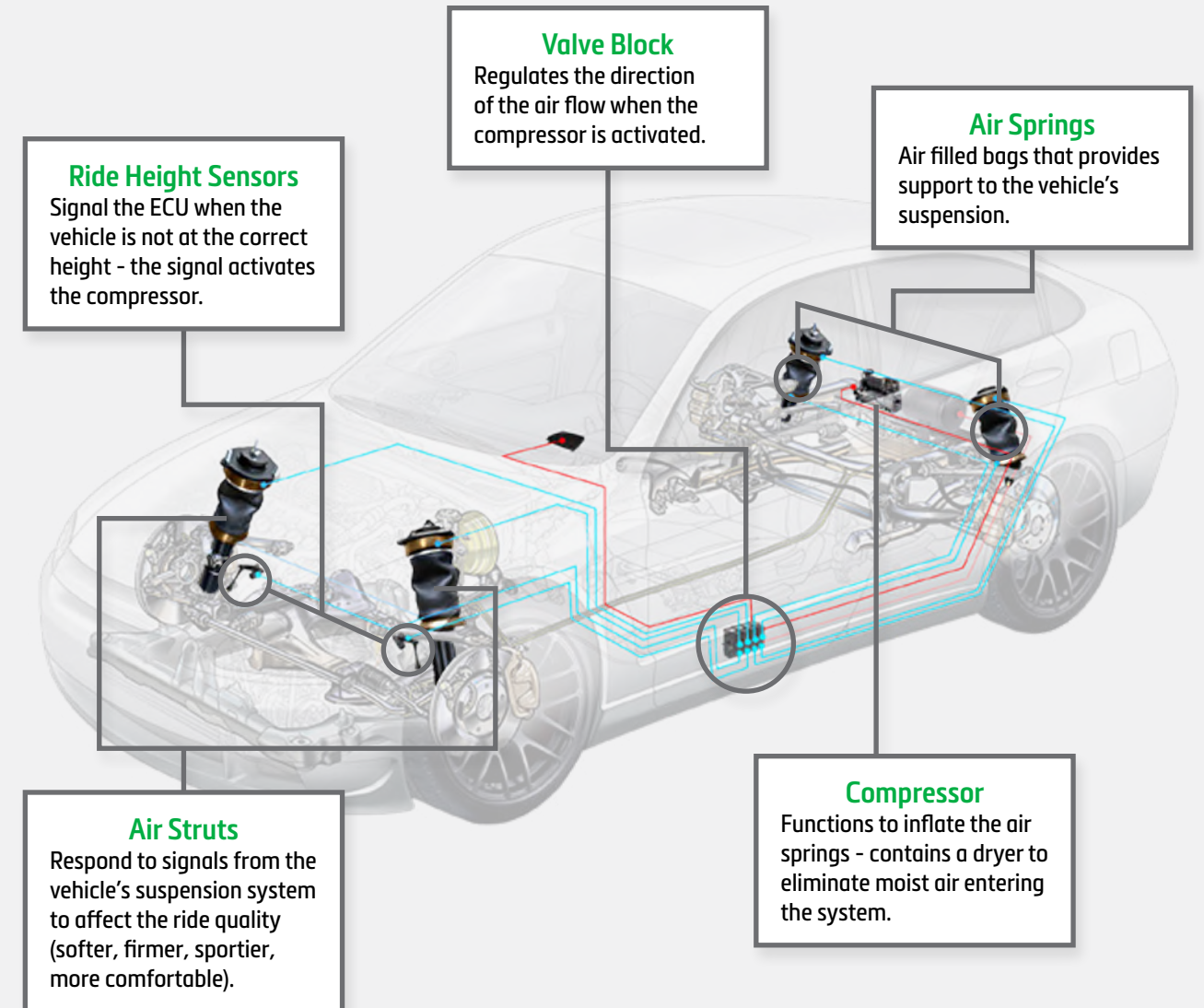













Air suspension systems use a compressor to inflate rubber air springs which may be separate from the shock absorber or combined with the damper as an air suspension strut. Height sensors give the ECU (Electronic Control Unit) a signal when the vehicle is not at a predetermined height and the compressor then pumps air into the air springs until the proper height is reached.









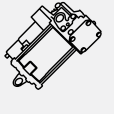
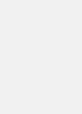









Like all rubber components, air springs and struts are wear and tear parts. Typically, the rubber will dry rot and small cracks form where the air bladder rolls upon itself. On average, an air suspension part will need to be replaced in six to ten years. Mileage, climate, driving conditions and off-road usage also influence the replacement rate.

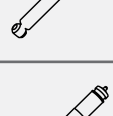

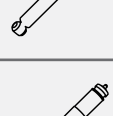
THE ARNOTT ADVANTAGE

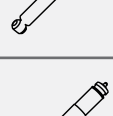

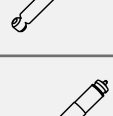



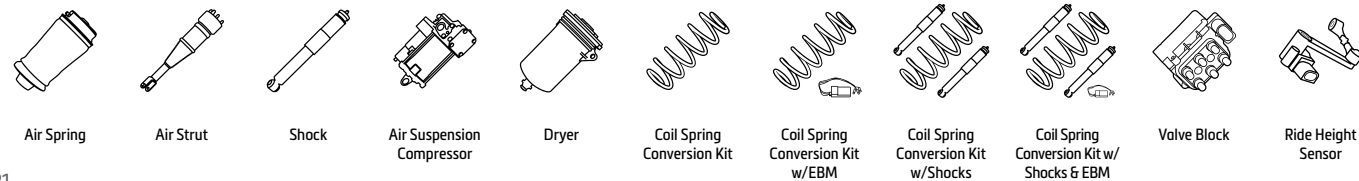







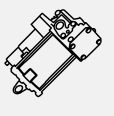
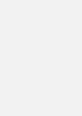
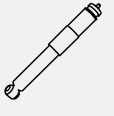

- ▲ Trusted for more than 30 years
- ▲ Premium components
- ▲ OE fit
- ▲ Broadest aftermarket coverage
- ▲ Simplified diagnosis & installation
- ▲ Additional sales & profit
- ▲ Superior support

CADILLAC				
Part #	Product Type	Position	Model Information	Attributes
E-body, G-body, K-body				
AS-2121 (Sold in Pairs)			1998-2001 Seville	SLS & STS (4.6 V8)
			2000-2005 DeVille	DTS Only (4.6)
AS-2125 (Sold in Pairs)			1993 Eldorado	All Models (Excl. ETC, 4.6)
			1993 Seville	SLS (4.6 V8)
			1994-1995 DeVille	Base Model (4.6, 4.9)
AS-2163 (Sold in Pairs)			1993-1995 Eldorado	ETC Model (4.6)
			1993-1994 Seville	SLS & STS (4.6 V8)
			1994-1995 DeVille	Concours (4.6)
			1994-1996 Eldorado	Base Model (4.6)
			1995-1996 Seville	SLS (4.6 V8)
			1996 DeVille	Base Model (4.6)
AS-2177 (Sold in Pairs)			1996-1999 DeVille	Concours (4.6)
			1996-2002 Eldorado	ETC Model (4.6)
			1996 Seville	STS (4.6 V8)
			1997 Seville	SLS & STS (4.6 V8)
AS-2185 (Sold in Pairs)			1997-1999 DeVille	Base Model (4.6, 4.9)
			1997-2002 Eldorado	Base Model (4.6)
AS-2190 (Sold in Pairs)			2000-2005 DeVille	All Models (Excl. DTS, 4.6)
			2002-2003 Seville	SLS & STS (4.6 V8)
			2004 Seville	SLS (4.6 V8)
MR-3446			2006-2011 DTS	w/MagneRide (4.6)
MR-3447			2006-2011 DTS	w/MagneRide (4.6)
MR-3448			2006-2011 DTS	w/MagneRide (4.6)
P-3021			1998-2004 Seville	4.6 V8
			2000-2005 DeVille	4.6, 4.9

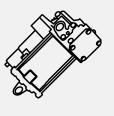
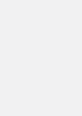







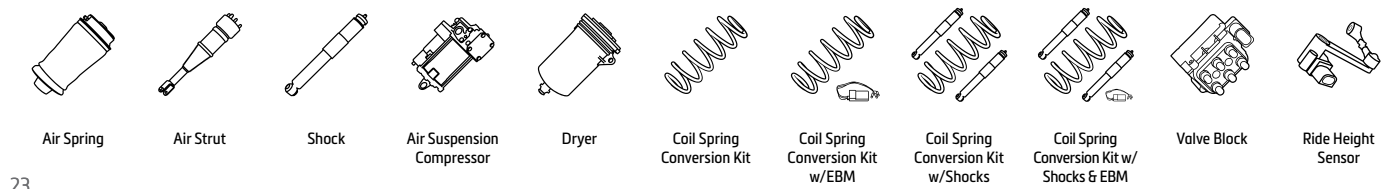





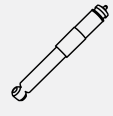

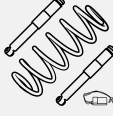

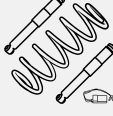

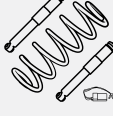

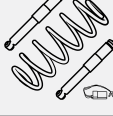
CADILLAC				
Part #	Product Type	Position	Model Information	Attributes
E-body, G-body, K-body				
SK-2111 (Sold in Pairs)			1993 Allante	4.6
SK-2118 (Sold in Pairs)			1995 DeVille	Base Model (4.6, 4.9)
SK-2162 (Sold in Pairs)			1993 Allante	4.6
			1993-1994 Eldorado	ETC Model (4.6)
			1993 Seville	STS (4.6 V8)
			1994 DeVille	Concours (4.6)
			1994 Eldorado	Base Model (4.6)
			1994 Seville	SLS & STS (4.6 V8)
			1995 DeVille	Concours (4.6)
SK-2167 (Sold in Pairs)			1995 Eldorado	Base & ETC Models (4.6)
			1996 Eldorado	Base Model (4.6)
			1995 Seville	SLS & STS (4.6 V8)
			1996 Seville	STS (4.6 V8)
			1996 DeVille	Base Model (4.6)
			1996 DeVille	Concours (4.6)
SK-2176 (Sold in Pairs)			1996 Eldorado	Base Model (4.6)
			1996 Seville	STS (4.6 V8)
			1997-1999 DeVille	Concours (4.6)
SK-2178 (Sold in Pairs)			1997-2002 Eldorado	ETC Model (4.6)
			1997 Seville	SLS & STS (4.6 V8)
			1997-1999 DeVille	Concours (4.6)
SK-2183 (Sold in Pairs)			1997-1999 DeVille	Base Model (4.6, 4.9)
			1997-2002 Eldorado	Base Model (4.6)
SK-2186 (Sold in Pairs)			1998-2001 Seville	SLS & STS (4.6 V8)
			2000-2001 DeVille	DTS Only (4.6)
SK-2189 (Sold in Pairs)			2000-2005 DeVille	All Models (Excl. DTS, 4.6)
			2002-2003 Seville	SLS & STS (4.6 V8)
			2004 Seville	SLS (4.6 V8)









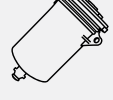







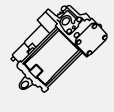

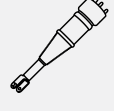

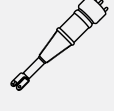



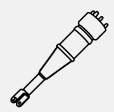

ENGINEERED TO RIDE, BUILT TO LAST.®

CADILLAC				
Part #	Product Type	Position	Model Information	Attributes
E-body, G-body, K-body				
SK-2264 (Sold in Pairs)			1993 Seville	SLS (4.6 V8)
			1994 DeVille	Base Model (4.6, 4.9)
Epsilon II				
A-3233			2013-2019 XTS	w/ & w/o AWD
				3.6, 3.6 AWD
P-3243			2013-2019 XTS	w/ & w/o AWD
				3.6, 3.6 AWD
SK-3357			2013-2019 XTS	w/ & w/o AWD
				3.6, 3.6 AWD
SK-3433			2013-2019 XTS	w/ & w/o AWD
				3.6, 3.6 AWD
F55				
AS-2950			2006-2011 DTS	w/MagneRide, w/Sport Suspension (4.6)
P-2982			2006-2011 DTS	4.6
SK-2952			2006-2011 DTS	w/MagneRide, w/Sport Suspension (4.6)
GMT265				
MR-3441			2004-2009 SRX	w/MagneRide
MR-3442			2004-2009 SRX	w/MagneRide

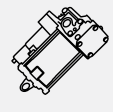
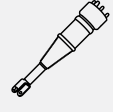

CADILLAC				
Part #	Product Type	Position	Model Information	Attributes
GMT806, GMT820, GMT830, GMT926, GMT936, GMT946				
AS-2708			2002-2014 Escalade	Short Wheelbase & Long Wheelbase (ESV, EXT) 5.7 AWD, 6.0, 6.0 AWD, 6.2, 6.2 AWD/FLEXFUEL/FLEXFUEL AWD
AS-2715			2002-2014 Escalade	Short Wheelbase & Long Wheelbase (ESV, EXT) 5.7 AWD, 6.0, 6.0 AWD, 6.2, 6.2 AWD/FLEXFUEL/FLEXFUEL AWD
AS-3430			2002-2014 Escalade	Short Wheelbase & Long Wheelbase (ESV, EXT), w/Autoride Suspension 5.7 AWD, 6.0, 6.0 AWD, 6.2, 6.2 AWD/FLEXFUEL/FLEXFUEL AWD
C-2666			2002-2006 Escalade	Short Wheelbase 5.7 AWD, 6.0, 6.0 AWD, 6.2, 6.2 AWD/FLEXFUEL/FLEXFUEL AWD
C-2667			2002-2006 Escalade	Long Wheelbase (ESV, EXT) 5.7 AWD, 6.0, 6.0 AWD, 6.2, 6.2 AWD/FLEXFUEL/FLEXFUEL AWD
C-2835			2007-2014 Escalade	Short Wheelbase 6.0 Hybrid/Hybrid AWD, 6.2, 6.2 AWD/FLEXFUEL/FLEXFUEL AWD/Flex/Flex AWD
C-2836			2007-2014 Escalade	Long Wheelbase (ESV, EXT) 6.0 Hybrid/Hybrid AWD, 6.2, 6.2 AWD/FLEXFUEL/FLEXFUEL AWD/Flex/Flex AWD
C-3182			2002-2006 Escalade	Short Wheelbase 5.7 AWD, 6.0, 6.0 AWD
C-3183			2002-2006 Escalade	Long Wheelbase (ESV, EXT) 5.7 AWD, 6.0, 6.0 AWD
C-3184			2007-2014 Escalade	Short Wheelbase 6.0 Hybrid/Hybrid AWD, 6.2, 6.2 AWD/FLEXFUEL/FLEXFUEL AWD/Flex/Flex AWD
C-3185			2007-2014 Escalade	Long Wheelbase (ESV, EXT) 6.0 Hybrid/Hybrid AWD, 6.2, 6.2 AWD/FLEXFUEL/FLEXFUEL AWD/Flex/Flex AWD
D-2803			2002-2014 Escalade	Short Wheelbase & Long Wheelbase (ESV, EXT) 5.7 AWD, 6.0, 6.0 AWD, 6.2, 6.2 AWD/FLEXFUEL/FLEXFUEL AWD

CADILLAC				
Part #	Product Type	Position	Model Information	Attributes
GMT806, GMT820, GMT830, GMT926, GMT936, GMT946				
MR-3435			2007-2014 Escalade	Short Wheelbase & Long Wheelbase (ESV, EXT) 5.7 AWD, 6.0, 6.0 AWD, 6.2, 6.2 AWD/FLEXFUEL/FLEXFUEL AWD
MR-3436			2007-2014 Escalade	Short Wheelbase & Long Wheelbase (ESV, EXT) 5.7 AWD, 6.0, 6.0 AWD, 6.2, 6.2 AWD/FLEXFUEL/FLEXFUEL AWD
MR-3568			2007-2014 Escalade	Short Wheelbase & Long Wheelbase (ESV, EXT) 5.7 AWD, 6.0, 6.0 AWD, 6.2, 6.2 AWD/FLEXFUEL/FLEXFUEL AWD
P-3242			2002-2014 Escalade	Short Wheelbase & Long Wheelbase (ESV, EXT) 5.7 AWD, 6.0/AWD/HYBRID/HYBRID AWD, 6.2/AWD/FLEXFUEL/FLEXFUEL AWD, Crew Cab Pickup 6.0 AWD, Crew Cab Pickup 6.2 AWD/LPG AWD
SK-2760			2002-2006 Escalade	Short Wheelbase & Long Wheelbase (ESV, EXT) 5.7 AWD, 6.0, 6.0 AWD, 6.2, 6.2 AWD/FLEXFUEL/FLEXFUEL AWD
SK-2806			2007-2014 Escalade	Short Wheelbase & Long Wheelbase (ESV, EXT) 6.0 Hybrid/Hybrid AWD, 6.2, 6.2 AWD/FLEXFUEL/FLEXFUEL AWD/Flex/Flex AWD
SK-2954			2007-2014 Escalade	Short Wheelbase & Long Wheelbase (ESV, EXT) 5.7 AWD, 6.0, 6.0 AWD, 6.2, 6.2 AWD/FLEXFUEL/FLEXFUEL AWD
SK-3062			2002-2006 Escalade	Short Wheelbase & Long Wheelbase (ESV, EXT) 5.7 AWD, 6.0/AWD, Crew Cab Pickup 6.0 AWD
GMTK2XL				
AS-3066			2015-2020 Escalade	Incl. ESV
C-3416			2015-2020 Escalade	Excl. ESV 6.2 AWD

CADILLAC				
Part #	Product Type	Position	Model Information	Attributes
GMTK2XL				
C-3432			2015-2020 Escalade	ESV 6.2 AWD
MR-3839			2015-2019 Escalade	w/MagneRide
P-3242			2015-2020 Escalade	Incl. ESV 6.2 AWD
SK-3354			2015-2020 Escalade	ESV w/MagneRide 6.2 AWD







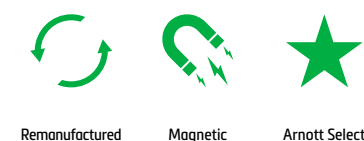
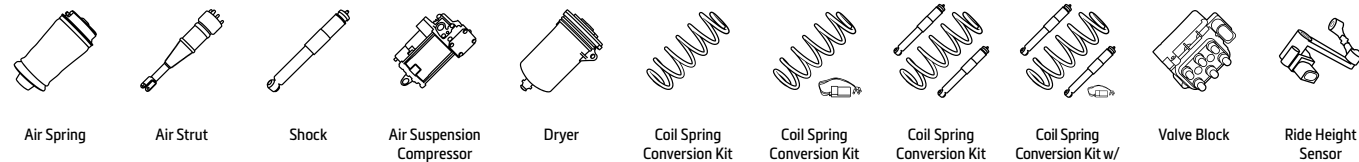





















NEW COIL-OVER STRUT

- Front shock for 15-20 GM SUVs (GMTK2xx w/MagneRide)
- Monotube damper precision-tuned to mimic an OE ride
- Continental ContiTech air sleeve
 - > Premium multi-ply, cross-corded construction
 - > Longer-lasting design using advanced materials
- New - not remanufactured, eliminates core handling
- Designed, assembled & tested in the USA
- SK-3354



ENGINEERED TO RIDE, BUILT TO LAST.®

CADILLAC				
Part #	Product Type	Position	Model Information	Attributes
GMX295				
MR-3437			2007-2010 STS	w/MagneRide, w/AWD 4.6 AWD
MR-3438			2007-2010 STS	w/MagneRide, w/RWD 3.6, 4.6
MR-3439			2007-2010 STS	w/MagneRide, w/RWD 3.6, 4.6, 4.6 AWD
MR-3440			2007-2010 STS	w/MagneRide, w/RWD 3.6, 4.6, 4.6 AWD
GMX322				
MR-3443			2009-2015 CTS-V	w/MagneRide 2.0 Turbo/Turbo AWD, 2.8, 3.0/AWD, 3.6/AWD, 6.2
MR-3444			2009-2015 CTS-V	w/MagneRide 2.0 Turbo/Turbo AWD, 2.8, 3.0/AWD, 3.6/AWD, 6.2
MR-3445			2009-2015 CTS-V	w/MagneRide 2.0 Turbo/Turbo AWD, 2.8, 3.0/AWD, 3.6/AWD, 6.2

CHEVROLET				
Part #	Product Type	Position	Model Information	Attributes
GMT360, GMT370				
A-2610			2002-2006 Trailblazer EXT	129" Wheelbase, 4.2 AWD
			2002-2009 Trailblazer	113" Wheelbase, 4.2 AWD
C-2137			2002-2009 Trailblazer	113" Wheelbase, 4.2 AWD
C-2285			2002-2006 Trailblazer EXT	129" Wheelbase, 4.2 AWD
P-2863			2002-2006 Trailblazer EXT	129" Wheelbase, 4.2 AWD
GMT805, GMT820, GMT830, GMT921, GMT931, GMT941				
AS-2708			2000-2006 Tahoe 1500	4x2, 4x4 (w/Autoride Suspension) 4.8 V8, 5.3, 5.3 AWD/V8 AWD, 6.0 V8
			2000-2014 Suburban 1500	4x2, 4x4 (w/Autoride Suspension) 5.3 AWD/Flex-Fuel 4WD, 8.1 AWD
			2002-2013 Avalanche 1500	4x2, 4x4 (w/Electronic Suspension) 2.3 AWD/Flex-Fuel/Flex-Fuel AWD, 8.1
			2007-2014 Tahoe 1500	4x2, 4x4 (w/Electronic Suspension) 5.3
AS-2715			2000-2006 Tahoe 1500	4x2, 4x4 (w/Autoride Suspension) 4.8 V8, 5.3, 5.3 AWD/V8 AWD, 6.0 V8
			2000-2014 Suburban 1500	4x2, 4x4 (w/Autoride Suspension) 5.3 AWD/Flex-Fuel 4WD, 8.1 AWD
			2002-2013 Avalanche 1500	4x2, 4x4 (w/Electronic Suspension) 2.3 AWD/Flex-Fuel/Flex-Fuel AWD, 8.1
			2007-2014 Tahoe 1500	4x2, 4x4 (w/Electronic Suspension) 5.3
AS-3430			2000-2006 Suburban 1500	4x2, 4x4 (w/Autoride Suspension)
			2000-2006 Tahoe 1500	4x2, 4x4 (w/Autoride Suspension) 4.8 V8, 5.3, 5.3 AWD/V8 AWD, 6.0 V8
			2002-2006 Avalanche 1500	4x2, 4x4 (w/Autoride Suspension) 5.3 AWD, 8.1
			2007-2013 Avalanche 1500	4x2, 4x4 (w/Autoride Suspension, w/MagneRide) 2.3 AWD/Flex-Fuel/Flex-Fuel AWD, 8.1
			2007-2014 Suburban 1500	4x2, 4x4 (w/Autoride Suspension, w/MagneRide) 5.3 AWD/Flex-Fuel 4WD, 8.1 AWD
			2007-2014 Tahoe 1500	4x2, 4x4 (w/Autoride Suspension, w/MagneRide) 5.3



Arnott's remanufactured OE struts maintain original equipment functionality including factory damping and ride as well as auto-leveling. After the strut is inspected, steam cleaned, and media blasted to bare metal, many of Arnott's remanufactured products are recharged with high-performance shock oil. Worn components, such as the piston, rod guides and seal pack are replaced before being repainted with corrosion inhibiting paint.

Returns Vehicle to OE Specifications

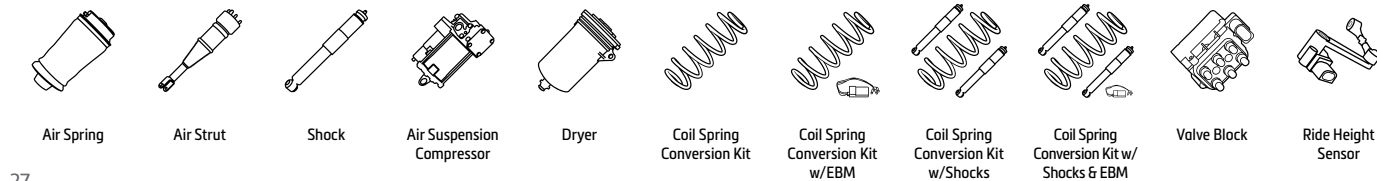





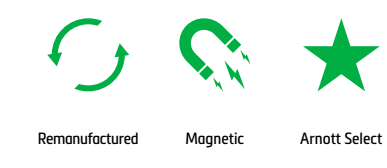
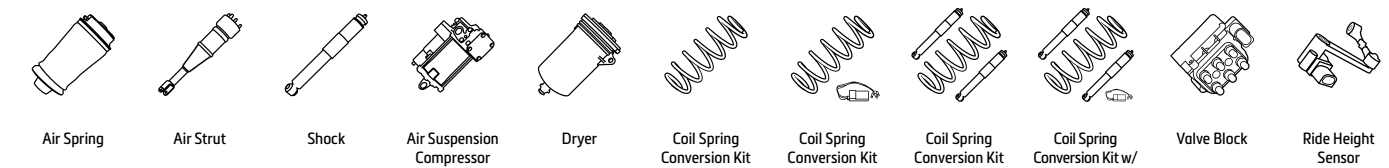







CHEVROLET				
Part #	Product Type	Position	Model Information	Attributes
GMT805, GMT820, GMT830, GMT921, GMT931, GMT941				
C-2666			2000-2006 Tahoe 1500	4x2, 4x4 (w/Autoride Suspension) 4.8 V8, 5.3, 5.3 AWD/V8 AWD, 6.0 V8, 8.1
C-2667			2000-2006 Suburban 1500	4x2, 4x4 (w/Autoride Suspension) 5.3 AWD, 8.1 AWD
			2002-2006 Avalanche 1500	4x2, 4x4 (w/Electronic Suspension)
C-2835			2007-2014 Tahoe 1500	4x2, 4x4 (w/Electronic Suspension) 2.3, 6.0 Flex/Hybrid 4WD
C-2836			2007-2013 Avalanche 1500	4x2, 4x4 (w/Electronic Suspension)
			2007-2014 Suburban 1500	4x2, 4x4 (w/Autoride Suspension)
C-3182			2000-2006 Tahoe 1500	4x2, 4x4 (w/Autoride Suspension) 4.8 V8, 5.3, 5.3 AWD/V8 AWD, 6.0 V8
C-3183			2000-2006 Suburban 1500	4x2, 4x4 (w/Autoride Suspension)
			2002-2006 Avalanche 1500	4x2, 4x4 (w/Electronic Suspension)
C-3184			2007-2014 Tahoe 1500	4x2, 4x4 (w/Electronic Suspension) 5.3, 5.3 Flex-Fuel/Flex-Fuel AWD, 6.0 Flex/Hybrid 4WD
C-3185			2007-2013 Avalanche 1500	4x2, 4x4 (w/Electronic Suspension)
			2007-2014 Suburban 1500	4x2, 4x4 (w/Autoride Suspension)
D-2803			2001-2006 Tahoe 1500	4x2, 4x4 (w/Autoride Suspension) 4.8 V8, 5.3, 5.3 AWD/V8 AWD, 6.0 V8
			2001-2014 Suburban 1500	4x2, 4x4 (w/Autoride Suspension) 5.3 AWD/Flex-Fuel 4WD
			2002-2013 Avalanche 1500	4x2, 4x4 (w/Electronic Suspension) 5.3 AWD/Flex-Fuel/Flex-Fuel AWD, 8.1
			2007-2014 Tahoe 1500	4x2, 4x4 (w/Electronic Suspension) 5.3

CHEVROLET				
Part #	Product Type	Position	Model Information	Attributes
GMT805, GMT820, GMT830, GMT921, GMT931, GMT941				
MR-3435			2007-2013 Avalanche 1500	4x2, 4x4 (w/Autoride Suspension)
			2007-2014 Suburban 1500	4x2, 4x4 (w/Electronic Suspension)
			2007-2014 Tahoe 1500	4x2, 4x4 (w/Electronic Suspension)
MR-3436			2007-2013 Avalanche 1500	4x2, 4x4 (w/Autoride Suspension)
			2007-2014 Suburban 1500	4x2, 4x4 (w/Electronic Suspension)
			2007-2014 Tahoe 1500	4x2, 4x4 (w/Electronic Suspension)
MR-3568			2007-2013 Avalanche 1500	4x2, 4x4 (w/Autoride Suspension)
			2007-2014 Suburban 1500	4x2, 4x4 (w/Electronic Suspension)
			2007-2014 Tahoe 1500	4x2, 4x4 (w/Electronic Suspension)
P-3242			2001-2006 Tahoe 1500	4x2, 4x4 (w/Autoride Suspension) 4.8 V8, 5.3, 5.3 AWD/V8 AWD, 6.0 V8
			2001-2014 Suburban 1500	4x2, 4x4 (w/Autoride Suspension) 5.3 AWD/Flex-Fuel 4WD
			2002-2013 Avalanche 1500	4x2, 4x4 (w/Electronic Suspension) 5.3 AWD/Flex-Fuel/Flex-Fuel AWD, 8.1
			2007-2014 Tahoe 1500	4x2, 4x4 (w/Electronic Suspension) 5.3
SK-2760			2000-2006 Suburban 1500	4x2, 4x4 (w/Autoride Suspension)
			2000-2006 Tahoe 1500	4x2, 4x4 (w/Autoride Suspension) 4.8 V8, 5.3, 5.3 AWD/V8 AWD, 6.0 V8
			2002-2006 Avalanche 1500	4x2, 4x4 (w/Electronic Suspension) 5.3 AWD, 8.1
SK-2806			2007-2013 Avalanche 1500	4x2, 4x4 (w/Electronic Suspension) 5.3 Flex-Fuel/Flex-Fuel AWD
			2007-2014 Suburban 1500	4x2, 4x4 (w/Autoride Suspension)
			2007-2014 Tahoe 1500	4x2, 4x4 (w/Electronic Suspension) 5.3, 6.0 Flex/Hybrid 4WD
SK-2954			2007-2013 Avalanche 1500	4x2, 4x4 (w/Electronic Suspension) 5.3 Flex-Fuel, 5.3 Flex-Fuel AWD
			2007-2014 Suburban 1500	4x2, 4x4 (w/Autoride Suspension) 5.3 Flex-Fuel 4WD
			2007-2014 Tahoe 1500	4x2, 4x4 (w/Electronic Suspension) 5.3
SK-3062			2000-2006 Suburban 1500	4x2, 4x4 (w/Autoride Suspension)
			2000-2006 Tahoe 1500	4x2, 4x4 (w/Autoride Suspension)
			2002-2006 Avalanche 1500	4x2, 4x4 (w/Electronic Suspension)

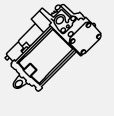

ENGINEERED TO RIDE, BUILT TO LAST.®

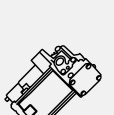
CHEVROLET				
Part #	Product Type	Position	Model Information	Attributes
GMTK2UC, GMTK2YC				
AS-3066			2015-2020 Suburban 1500	
			2015-2020 Tahoe 1500	6.2 4WD
C-3416			2015-2020 Tahoe 1500	6.2 4WD
C-3432			2015-2020 Suburban 1500	6.2 4WD
MR-3839			2015-2020 Suburban 1500	6.0
			2015-2020 Tahoe 1500	6.2 4WD
P-3242			2015-2020 Suburban 1500	6.0
			2015-2020 Tahoe 1500	6.2 4WD
SK-3354			2015-2020 Suburban 1500	w/MagneRide
			2015-2020 Tahoe 1500	w/MagneRide
GMTK2HC				
MR-3841			2015-2019 Silverado	w/MagneRide
P-3242			2015-2019 Silverado	Crew Cab Pickup 5.3/6.2 4WD
				Extended Cab Pickup 5.3/6.2 4WD
				Standard Cab Pickup 5.3 4WD
			2015-2019 Cheyenne	Crew Cab Pickup 6.2 4WD
				Standard Cab Pickup 6.2 4WD

Air springs in a vehicle's suspension are durable rubber sleeves that are inflated and deflated through electronic inputs to create a smooth, controlled ride. An air spring can be connected to a vehicle's axle or integrated onto the suspension strut.

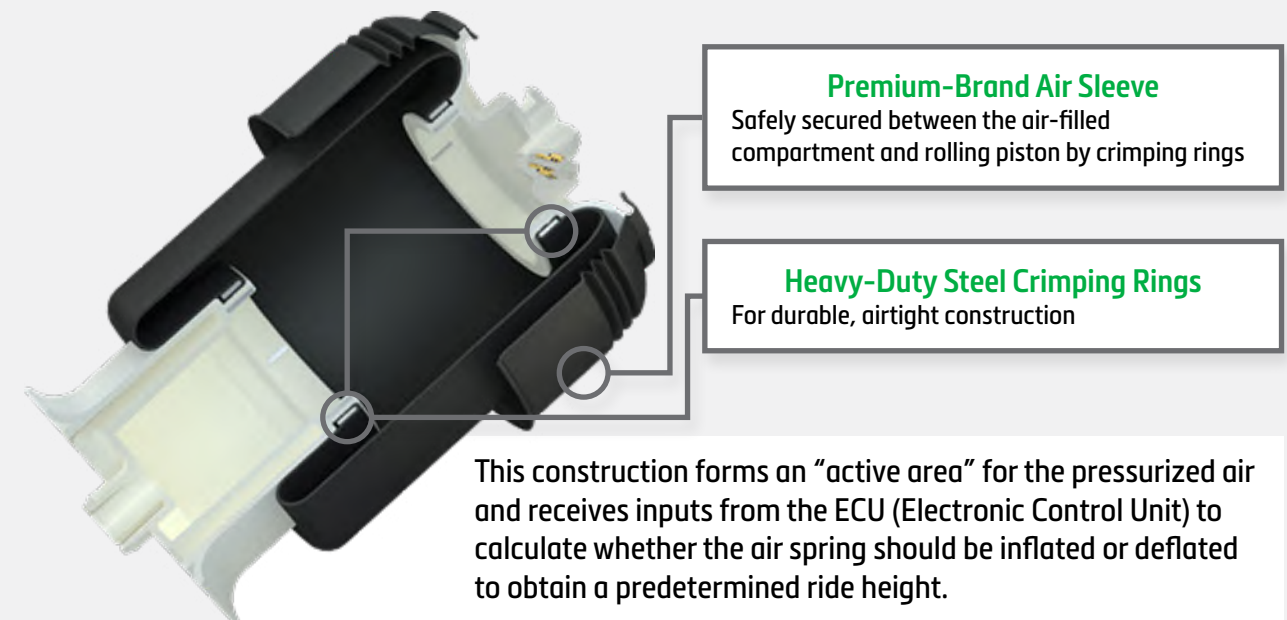

TECH TIP: LEAKS

Most air suspension problems occur because one or more of a vehicle's air springs have deteriorated and developed leaks. Thin rubber air sleeves and seals combined with weak crimping rings are common problems in many low-quality knock-offs and some stock air springs.



An air suspension leak is easy to find by spraying the air springs, struts and fittings with a soap and water solution. Bubbles will indicate where the leak or leaks are.

Arnott air springs feature multi-ply sleeves manufactured by industry-leading companies and are engineered to address the common problems many springs develop.





THE ARNOTT ADVANTAGE



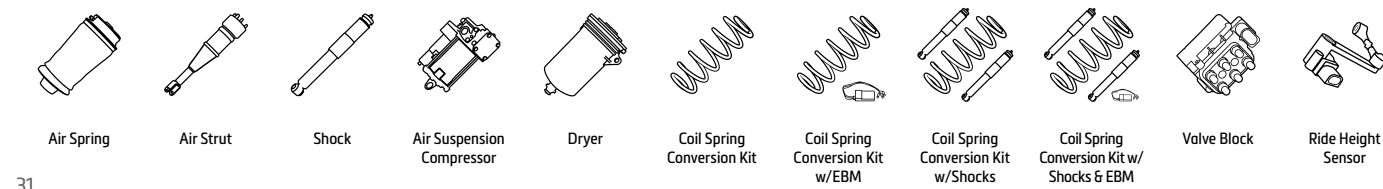







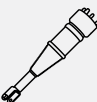

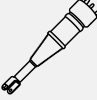
- ▲ Long-lasting, premium-brand, multi-ply air sleeve manufactured by industry-leading companies
- ▲ Improved design installs up to 94% faster than OE
- ▲ Quick, economical repair option





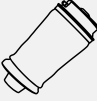









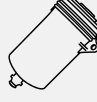
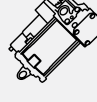



ARNOTT OFFERS AIR SPRINGS FOR:

Audi • BMW • Buick • Cadillac • Chevrolet • Citroën • Ford • GMC • Hummer • Iveco • Jeep • Land Rover • Lexus • Lincoln • Mercedes-Benz • Mercury • Oldsmobile • Porsche • Ram • Saab • Toyota • Volkswagen • Volvo



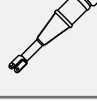





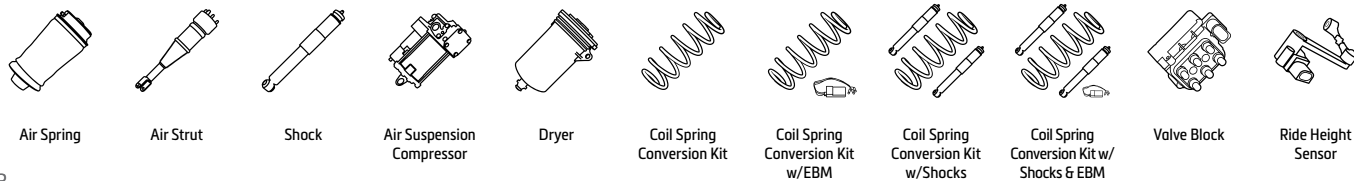







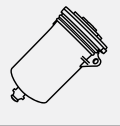
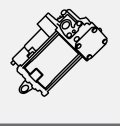
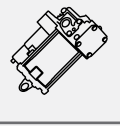
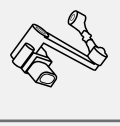

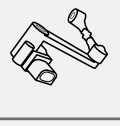
CITROËN				
Part #	Product Type	Position	Model Information	Attributes
PF2				
A-2939			2006-2013 C4 Grand Picasso	1.2 THP 130, 1.6 16V/BlueHDi 100/BlueHDi 120/HDi/BlueHDi 115/HDi 110/HDi 90/THP 140/THP 150/THP 155/THP 165/VTi 120, 1.8 Bifuel/i 16V, 2.0 BlueHDi 135/BlueHDi 150/HDi 138/HDi 150/HDi 165/i 16V
P-2854	 OES		2006-2013 C4 Grand Picasso	1.6 16V/HDi/HDi 110/THP 155/VTi 120, 1.8 i 16V, 2.0 HDi 138/HDi 150/HDi 165/i 16V
VF7				
P-2851	 OES		2007-2016 Jumpy	1.6 HDi 90 16V/8V, 2.0 HDi 120/HDi 125/HDi 140/HDi 165/HDi 95/i



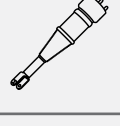

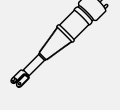



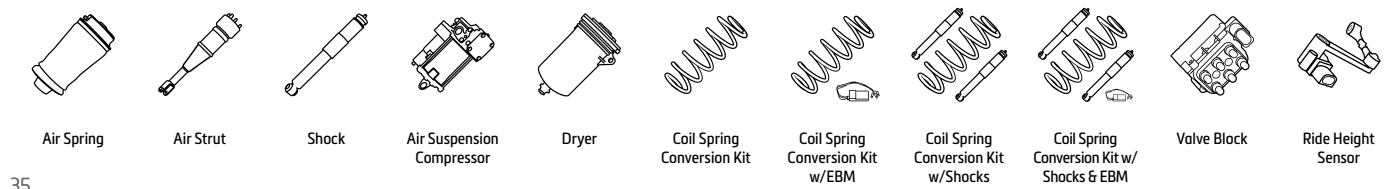

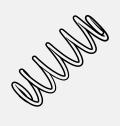

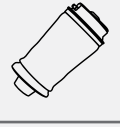

FORD				
Part #	Product Type	Position	Model Information	Attributes
CD391				
SK-3599			2013-2016 Fusion	
SK-3600			2013-2016 Fusion	
SK-3610			2013-2016 Fusion	
SK-3611			2013-2016 Fusion	
Panther				
A-2105			1992-2011 Crown Victoria	4.6 Liter V8
A-2220			1992-2011 Crown Victoria	Heavy Duty for Limousine Use, 4.6 Liter V8

FORD				
Part #	Product Type	Position	Model Information	Attributes
Panther				
C-2614			1992-2002 Crown Victoria	4.6 Liter V8
C-2615			2003-2011 Crown Victoria	4.6 Liter V8
D-2171			1992-2011 Crown Victoria	4.6 Liter V8
P-2936			1992-2011 Crown Victoria	4.6 Liter V8
U93, U222, U324				
A-2143			2003-2006 Expedition	2 Wheel Drive & 4 Wheel Drive
A-2148			1997-2002 Expedition	2 Wheel Drive
A-2153			1997-2002 Expedition	4 Wheel Drive
A-2647			2007-2014 Expedition	2 Wheel Drive & 4 Wheel Drive
A-2735			2003-2006 Expedition	2 Wheel Drive & 4 Wheel Drive
AS-2139			2003-2006 Expedition	2 Wheel Drive & 4 Wheel Drive
C-2140			2003-2006 Expedition	2 Wheel Drive & 4 Wheel Drive

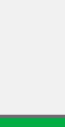

FORD				
Part #	Product Type	Position	Model Information	Attributes
U93, U222, U324				
C-2529			2007-2014 Expedition	2 Wheel Drive & 4 Wheel Drive (AWD/RWD)
C-2607			1997-2002 Expedition	2 Wheel Drive (RWD)
C-2608			1997-2002 Expedition	4 Wheel Drive
D-2155			1997-2006 Expedition	2 Wheel Drive & 4 Wheel Drive
P-2932			1997-2006 Expedition	2 Wheel Drive & 4 Wheel Drive
P-2937			2007-2017 Expedition	2 Wheel Drive & 4 Wheel Drive
RH-3569			2007-2014 Expedition	2 Wheel Drive & 4 Wheel Drive
RH-3570			2007-2014 Expedition	2 Wheel Drive & 4 Wheel Drive
SK-2723			2003-2006 Expedition	2 Wheel Drive & 4 Wheel Drive
SK-3597			2015-2017 Expedition	2 Wheel Drive & 4 Wheel Drive
SK-3598			2015-2017 Expedition	2 Wheel Drive & 4 Wheel Drive

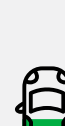

FORD				
Part #	Product Type	Position	Model Information	Attributes
WIN88, WIN126				
C-2175			1995-2003 Windstar	w/Load Leveling Rear Air Suspension 3.0 V6, 3.8, 3.8 V6
GMC				
Part #	Product Type	Position	Model Information	Attributes
GMT305, GMT360, GMT370				
A-2610			2002-2006 Envoy XL	129" Wheelbase
			2002-2006 Envoy XUV	129" Wheelbase
			2002-2009 Envoy	113" Wheelbase
C-2137			2002-2009 Envoy	113" Wheelbase
C-2285			2002-2006 Envoy XL	129" Wheelbase
			2002-2006 Envoy XUV	129" Wheelbase
P-2863			2002-2006 Envoy XL	129" Wheelbase
			2002-2006 Envoy XUV	129" Wheelbase
GMT820, GMT830, GMT922, GMT932				
AS-2708			2000-2014 Yukon 1500	All Models w/Autoride 6.2 4WD
			2000-2014 Yukon XL 1500	All Models w/Autoride
AS-2715			2000-2014 Yukon 1500	All Models w/Autoride 6.2 4WD
			2000-2014 Yukon XL 1500	All Models w/Autoride
AS-3430			2000-2006 Yukon 1500	All Models w/Autoride 6.2 4WD
			2000-2006 Yukon XL 1500	All Models w/Autoride
			2007-2014 Yukon 1500	All Models w/Autoride,w/MagneRide 5.3, 6.2, 6.2 4WD
			2007-2014 Yukon XL 1500	All Models w/Autoride,w/MagneRide 6.0, 6.0 4WD

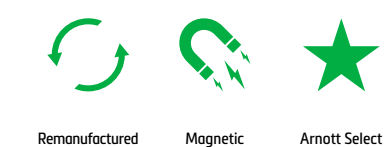

ENGINEERED TO RIDE, BUILT TO LAST.®

GMC				
Part #	Product Type	Position	Model Information	Attributes
GMT820, GMT830, GMT922, GMT932				
C-2666			2000-2006 Yukon 1500	All Models w/Autoride
C-2667			2000-2006 Yukon XL 1500	All Models w/Autoride
C-2835			2007-2014 Yukon 1500	All Models w/Autoride
				5.3, 6.2, 6.2 4WD
C-2836			2007-2014 Yukon XL 1500	All Models w/Autoride
				6.0, 6.0 4WD
C-3182			2000-2006 Yukon 1500	All Models w/Autoride
C-3183			2000-2006 Yukon XL 1500	All Models w/Autoride
C-3184			2007-2014 Yukon 1500	All Models w/Autoride
				5.3, 6.2, 6.2 4WD
C-3185			2007-2014 Yukon XL 1500	All Models w/Autoride
				6.0, 6.0 4WD
D-2803			2000-2014 Yukon 1500	All Models w/Autoride
				6.2 4WD
MR-3435			2007-2014 Yukon 1500	All Models w/Autoride
				2007-2014 Yukon XL 1500

GMC				
Part #	Product Type	Position	Model Information	Attributes
GMT820, GMT830, GMT922, GMT932				
MR-3436			2007-2014 Yukon 1500	All Models w/Autoride
				2007-2014 Yukon XL 1500
MR-3568			2007-2014 Yukon 1500	All Models w/Autoride
				2007-2014 Yukon XL 1500
P-3242			2000-2014 Yukon 1500	All Models w/Autoride
				2000-2014 Yukon XL 1500
SK-2760			2000-2006 Yukon 1500	All Models w/Autoride
				2000-2006 Yukon XL 1500
SK-2806			2007-2014 Yukon 1500	All Models w/Autoride
				2007-2014 Yukon XL 1500
SK-2954			2007-2014 Yukon 1500	All Models w/Autoride (Excl. Hybrids)
				6.2 4WD
			2007-2014 Yukon XL 1500	All Models w/Autoride (Excl. Hybrids)



ARNOTT NEW AIR SUSPENSION COMPRESSOR

- Air suspension compressor for GM SUVs (GMT8xx/9xx/K2xx Chassis)
- Includes integrated dryer & new relay
- Heavy-duty motor provides a long life
- Includes thermal overload protection
- Electroplated finish to prevent corrosion
- P-3242

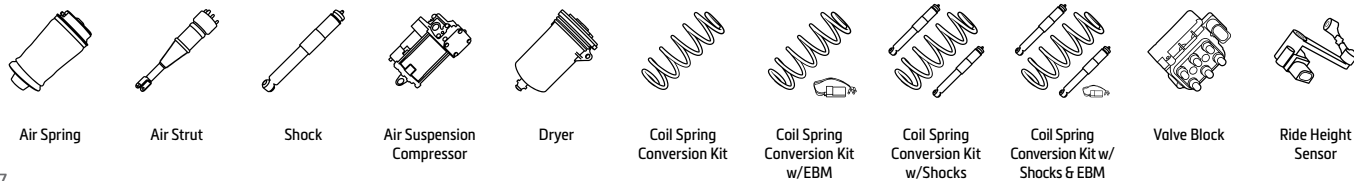

GMC				
Part #	Product Type	Position	Model Information	Attributes
GMT820, GMT830, GMT922, GMT932				
SK-3062			2000-2006 Yukon 1500	All Models w/Autoride
			2000-2006 Yukon XL 1500	All Models w/Autoride
GMTK2UG, GMTK2YG				
AS-3066			2015-2020 Yukon 1500	
			2015-2020 Yukon XL 1500	
C-3416			2015-2020 Yukon 1500	
C-3432			2015-2020 Yukon XL 1500	
MR-3839			2015-2019 Yukon 1500	w/MagneRide
P-3242			2015-2020 Yukon 1500	
			2015-2020 Yukon XL 1500	
SK-3354			2015-2020 Yukon 1500	w/MagneRide
			2015-2020 Yukon XL 1500	w/MagneRide
GMTK2HG				
MR-3841			2015-2019 Sierra	w/MagneRide
P-3242			2015-2019 Sierra	Crew Cab Pickup 5.3 4WD/6.2
				Extended Cab Pickup 5.3 4WD

HUMMER				
Part #	Product Type	Position	Model Information	Attributes
GMT820				
A-3753			2003-2007 H2 Series	w/Rear Air Suspension
				Closed Off-Road Vehicle 6.0 AWD, SUT 6.0 AWD, SUT 6.2 AWD, 6.0 AWD, 6.2 AWD
C-2987			2003-2007 H2 Series	w/Rear Air Suspension
				Closed Off-Road Vehicle 6.0 AWD, SUT 6.0 AWD, 6.2 AWD
C-2988			2008-2009 H2 Series	w/Rear Air Suspension
				6.2 Flex AWD







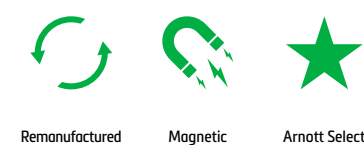
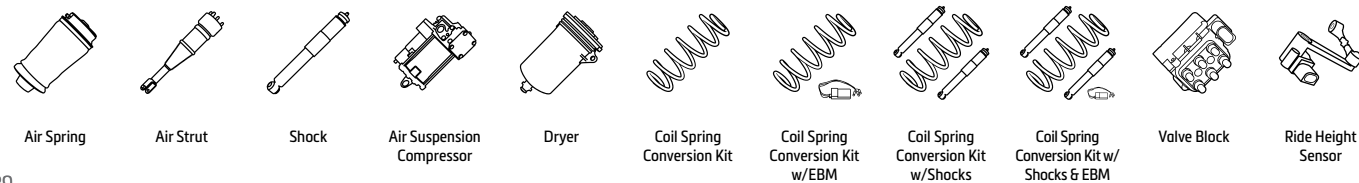

NEW OES AIR SPRING

- Rear air spring for 03-07 Hummer H2 Series (GMT820)
- New OE air spring from Firestone
- Heavy-duty crimping rings
- High-impact resin pistons
- A-3753

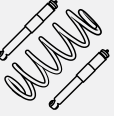

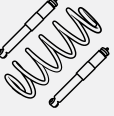

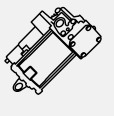
ENGINEERED TO RIDE, BUILT TO LAST.®











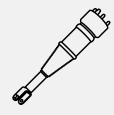

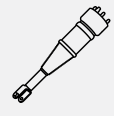

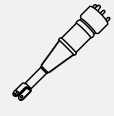

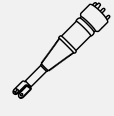
INFINITI				
Part #	Product Type	Position	Model Information	Attributes
JA60				
AS-3284			2004-2010 QX56	4 Wheel Drive 5.6 4WD
C-3421			2004-2010 QX56	4 Wheel Drive 5.6 4WD
C-3434			2004-2010 QX56	RWD 5.6
P-3277			2004-2010 QX56	4 Wheel Drive 5.6 4WD

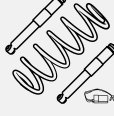

ARNOTT NEW AIR STRUT

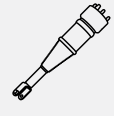
- Rear air strut for 04-10 Infiniti QX56 & 05-15 Nissan Armada (J/WA60)
- Continental ContiTech air sleeve
 - › Premium multi-ply, cross-corded construction
 - › Longer-lasting design using advanced materials
- New - not remanufactured, eliminates core handling
- Designed, assembled & tested in the USA
- AS-3284

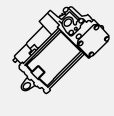
IVECO				
Part #	Product Type	Position	Model Information	Attributes
A-3276			1999-2015 Daily 35/50, Daily III, IV, V, VI, EcoDaily	35 (C 14, C 15, C10 K, C12, C13K, C13DKP, C15, C15 V, C15 V/P, C18) 40 (C 10 (AEJB14A1), C 11, C 13, C 14, C 15, C10, C10 V, C11 V, C11, C11 D, C12, C12 V, C14 V/P, C13 V, C13 V/P, C13, C13/P, C14 G, C14 G/P, C14 GV, C14 GV/P, C14 K, C14 DK, C14 V, C14 V/P, C14, C14 /P, C15, C15 V, C15 V/P, C17 K, C17 DK, C17 V, C17 V/P, C17, C17/P, C18, C18 V, C18 V/P) 50 (C 11, C 11 Natural Power (CNG), C 13, C 14, C 15, C 17, C Electric, C14 G, C14 G/P, C14 GD, C14 GD/P, C14 GV, C14 GV/P, C14 K, C14 DK, C14 Natural Power, C14 V, C14 V/P, C14, C14/P, C15, C15 V, C15 V/P, C17 K, C17 DK, C17 V, C17 V/P, C17, C17/P, C18, C18 V, C18 V/P)

JAGUAR				
Part #	Product Type	Position	Model Information	Attributes
X350, X358				
AS-2888			2004-2009 XJ Series	w/Comfort Suspension 3.0, 3.6, 4.2, D 2.7, R 4.2
AS-2889			2004-2009 XJ Series	w/Comfort Suspension 3.0, 3.6, 4.2, D 2.7, R 4.2
AS-2890			2004-2009 XJ Series	w/Sport Suspension 3.0, 3.6, 4.2, D 2.7, R 4.2
AS-2891			2004-2009 XJ Series	w/Sport Suspension 3.0, 3.6, 4.2, D 2.7, R 4.2
C-2745			2004-2009 XJ Series	3.0, 3.6, 4.2, D 2.7, R 4.2
P-2291	 OES		2004-2009 XJ Series	3.0, 3.6, 4.2, D 2.7, R 4.2
VB-3492			2004-2009 XJ Series	3.0, 3.6, 4.2, D 2.7, R 4.2
X351				
AS-3234			2011-2019 XJ Series	w/AWD or RWD, Short Wheelbase & Long Wheelbase 2.0, 3.0, 3.0 AWD/D, 5.0, 5.0 R575/V8
P-3244			2010-2019 XJ Series	w/AWD or RWD, Short Wheelbase & Long Wheelbase 2.0, 3.0, 3.0 AWD/D, 5.0, 5.0 R575/V8
P-3733	 OES		2010-2015 XJ Series	w/AWD or RWD, Short Wheelbase & Long Wheelbase 2.0, 3.0, 3.0 AWD/D, 5.0, 5.0 R575/V8

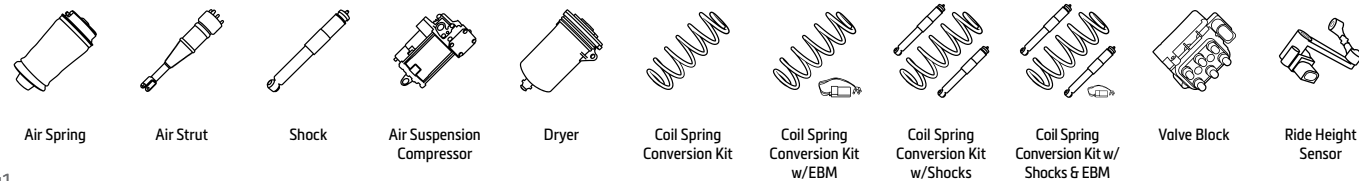

Arnott's engineers apply more than 30 years of remanufacturing experience and knowledge to every new strut they design and continually improve their ability to design new air struts that replicate the OE-like ride drivers expect.

Weaknesses in the OE design are improved and Arnott's new struts are built with Tier 1 components, including longer-lasting seals, new polyurethane bump stops, heavy-duty crimping rings and name-brand, dust baffles.

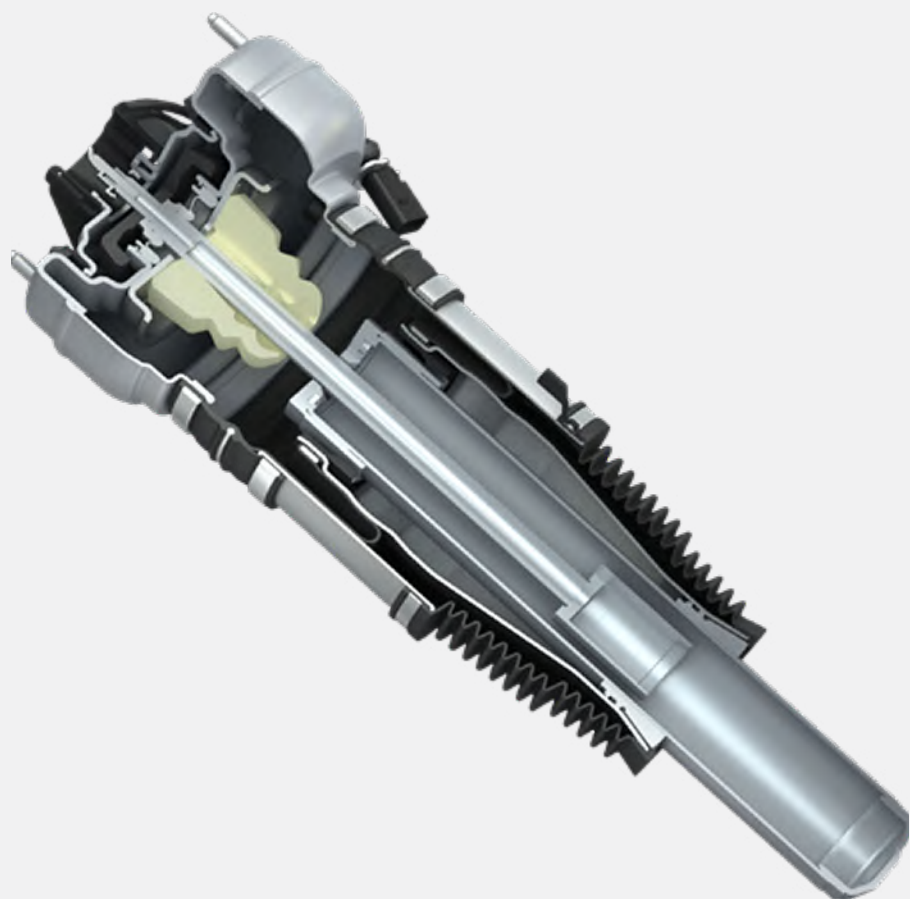

THE ARNOTT ADVANTAGE

- ▲ Precision-tuned, Eibach monotube damper in many applications
- ▲ Premium brand air sleeves, bump stop & dust boot
- ▲ Works with vehicle's auto-leveling functionality
- ▲ Improved seals to prevent leaks
- ▲ Designed, assembled & tested in the USA

ARNOTT OFFERS NEW AIR STRUTS FOR:

Audi • Bentley • BMW • Buick • Cadillac • Chevrolet • Ford • GMC • Infiniti • Jaguar • Jeep • Land Rover • Lexus
Lincoln • Mercedes-Benz • Nissan • Oldsmobile • Pontiac • Porsche • Ram • Tesla • Volkswagen • Volvo

JEEP				
Part #	Product Type	Position	Model Information	Attributes
WK2				
A-3010			2011-2018 Grand Cherokee	3.0 4x4/CRD/CRD V6 4x4, 3.6 V6 4x4/V6 FlexFuel 4x4/VVT 4x4, 5.7 V8 4x4, 6.4 SRT8 4x4
AS-3248			2016-2020 Grand Cherokee	w/Quadra-Lift, w/o Sport 3.6 VVT 4x4, 6.2 4x4, 6.2 i V8 4x4
AS-3249			2016-2020 Grand Cherokee	w/Quadra-Lift, w/o Sport 3.6 VVT 4x4, 6.2 4x4, 6.2 i V8 4x4
AS-3250			2016-2020 Grand Cherokee	w/Quadra-Lift, w/o Sport 3.6 VVT 4x4, 6.2 4x4, 6.2 i V8 4x4
AS-3251			2016-2020 Grand Cherokee	w/Quadra-Lift, w/o Sport 3.6 VVT 4x4, 6.2 4x4, 6.2 i V8 4x4











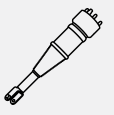

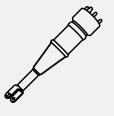

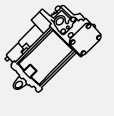
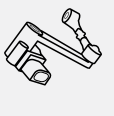

ARNOTT NEW AIR STRUTS

- Front air struts for 16-20 Jeep Grand Cherokee (WK2 Chassis)
- Continental ContiTech air sleeve
 - > Premium multi-ply, cross-corded construction
 - > Longer-lasting design using advanced materials
- New - not remanufactured, eliminates core handling
- Designed, assembled & tested in the USA
- AS-3248 (front right) & AS-3249 (front left)

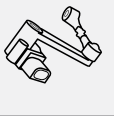



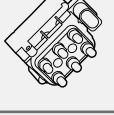
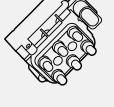

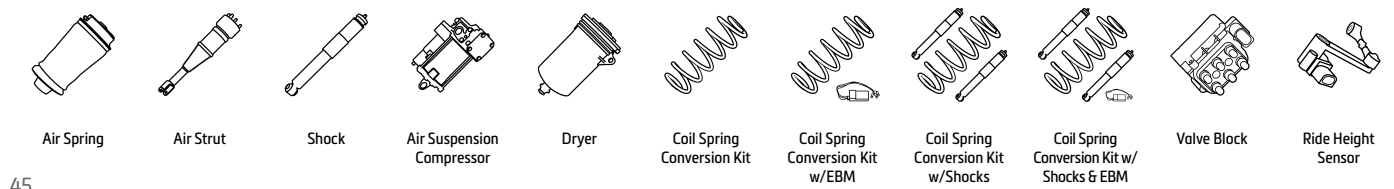







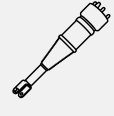

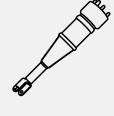

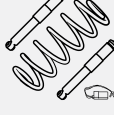



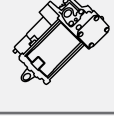



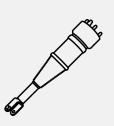

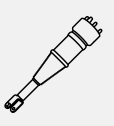

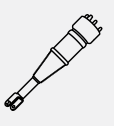

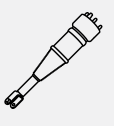
ENGINEERED TO RIDE, BUILT TO LAST.®

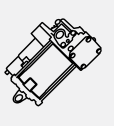
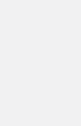

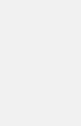
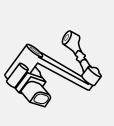

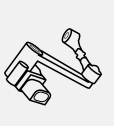











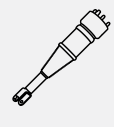

JEEP				
Part #	Product Type	Position	Model Information	Attributes
WK2				
AS-3289			2011-2015 Grand Cherokee	w/Quadra-Lift, w/o Sport 3.0 4x4/CRD/CRD V6 4x4, 3.6 V6 4x4/V6 FlexFuel 4x4, 5.7 4x4/V8 4x4, 6.4 SRT8 4x4
AS-3290			2011-2015 Grand Cherokee	w/Quadra-Lift, w/o Sport 3.0 4x4/CRD/CRD V6 4x4, 3.6 V6 4x4/V6 FlexFuel 4x4, 5.7 4x4/V8 4x4, 6.4 SRT8 4x4
AS-3323	 ★		2011-2015 Grand Cherokee	w/Quadra-Lift, w/o Sport 3.0 4x4/CRD/CRD V6 4x4, 3.6 V6 4x4/V6 FlexFuel 4x4/VVT 4x4, 5.7 4x4/V8 4x4, 6.2 4x4/i V8 4x4
AS-3324	 ★		2011-2015 Grand Cherokee	w/Quadra-Lift, w/o Sport 3.0 4x4/CRD/CRD V6 4x4, 3.6 V6 4x4/V6 FlexFuel 4x4/VVT 4x4, 5.7 4x4/V8 4x4, 6.2 4x4/i V8 4x4
P-3245			2011-2020 Grand Cherokee	3.0 4x4/CRD/CRD V6 4x4/TD V6 4x4/V6 4x4, 3.6 V6/V6 4x4/V6 FlexFuel 4x4/VVT/VVT 4x4, 5.7 4x4/V8 4x4, 6.2 4x4/i V8 4x4, 6.4 SRT8 4x4
RH-3711			2011-2015 Grand Cherokee	
RH-3712			2011-2015 Grand Cherokee	
SK-3394			2011-2015 Grand Cherokee	w/Quadra-Lift 3.0 4x4/CRD/CRD V6 4x4, 3.6 V6 4x4/V6 FlexFuel 4x4/VVT 4x4, 5.7 4x4/V8 4x4, 6.2 4x4/i V8 4x4, 6.4 SRT8 4x4
VB-3470			2011-2020 Grand Cherokee	3.0 4x4/CRD/CRD V6 4x4, 3.6 V6 4x4/V6 FlexFuel 4x4/VVT 4x4, 5.7 V8 4x4, 6.4 SRT8 4x4
VB-3824			2011-2020 Grand Cherokee	3.0 4x4/CRD/CRD V6 4x4, 3.6 V6 4x4/V6 FlexFuel 4x4/VVT 4x4, 5.7 V8 4x4, 6.4 SRT8 4x4

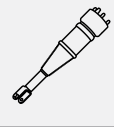

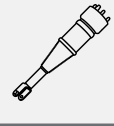
LAMBORGHINI				
Part #	Product Type	Position	Model Information	Attributes
P-3473	 OES		2018-2020 Urus	

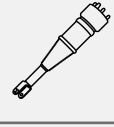

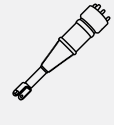



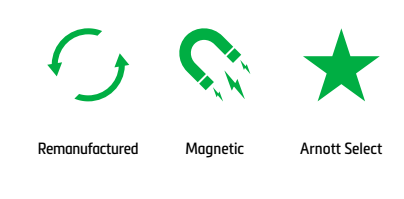
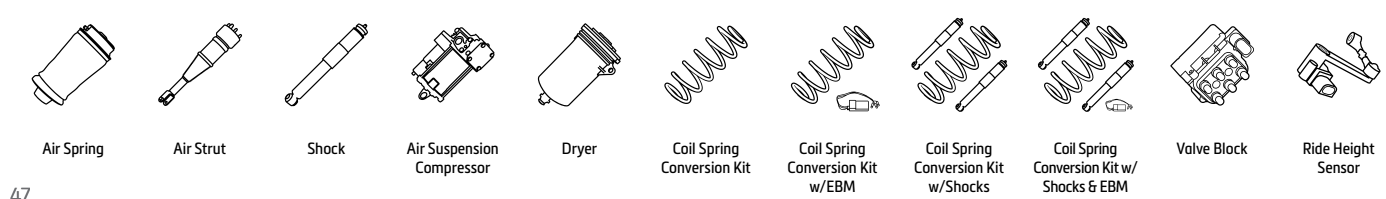



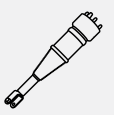

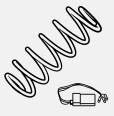
LAND ROVER				
Part #	Product Type	Position	Model Information	Attributes
L318				
A-2202			1998-2004 Discovery II	2.5 Td5, 4.0 V8
C-2203			1998-2004 Discovery II	2.5 Td5, 4.0 V8
P-2495	 OES		1998-2004 Discovery II	2.5 Td5, 4.0 V8
L319				
AS-2534			2005-2009 Discovery LR3 2010-2016 Discovery LR4	2.7 TD, 4.0, 4.0 V6, 4.4 2.7 TD, 3.0, 3.0 TD, 4.0, 5.0 V8
AS-2809			2005-2009 Discovery LR3 2010-2016 Discovery LR4	2.7 TD, 4.0, 4.0 V6, 4.4 2.7 TD, 3.0, 3.0 TD, 4.0, 5.0 V8
C-3619			2005-2009 Discovery LR3	2.7 TD, 4.0, 4.0 V6, 4.4
C-3620			2010-2016 Discovery LR4	2.7 TD, 3.0, 3.0 TD, 4.0, 5.0 V8
P-3431			2005-2009 Discovery LR3 2010-2016 Discovery LR4	2.7 TD, 4.0, 4.0 V6, 4.4 2.7 TD, 3.0, 3.0 TD, 4.0, 5.0 V8
P-3730	 OES		2005-2009 Discovery LR3 2010-2016 Discovery LR4	2.7 TD, 4.0, 4.0 V6, 4.4 2.7 TD, 3.0, 3.0 TD, 4.0, 5.0 V8

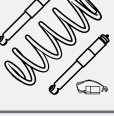

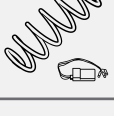

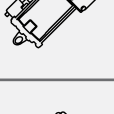
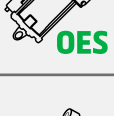
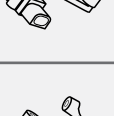

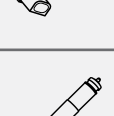

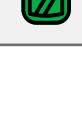

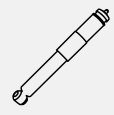
LAND ROVER				
Part #	Product Type	Position	Model Information	Attributes
L320				
AS-2534			2006-2013 Range Rover Sport	Incl. Supercharged 2.7 D, 3.0 D, 3.6 D, 4.2, 4.4, 5.0
AS-2761			2010-2013 Range Rover Sport	w/VDS, Supercharged 3.0 D
AS-2762			2010-2013 Range Rover Sport	w/VDS, Supercharged 3.0 D
AS-2809			2006-2013 Range Rover Sport	Incl. Supercharged 2.7 D, 3.0 D, 3.6 D, 4.2, 4.4, 5.0
P-3431			2006-2013 Range Rover Sport	Incl. Supercharged 2.7 D, 3.0 D, 3.6 D, 4.2, 4.4, 5.0
			2010-2013 Range Rover Sport	w/VDS 2.7 D, 3.0 D, 3.6 D, 4.2, 4.4, 5.0
P-3730			2006-2013 Range Rover Sport	Incl. Supercharged 2.7 D, 3.0 D, 3.6 D, 4.2, 4.4, 5.0
			2010-2013 Range Rover Sport	w/VDS 2.7 D, 3.0 D, 3.6 D, 4.2, 4.4, 5.0
RH-3454			2010-2013 Range Rover Sport	w/VDS 2.7 D 4x4, 3.0 D 4x4, 3.6 D 4x4, 4.2 4x4, 4.4 4x4, 5.0 4x4
RH-3455			2010-2013 Range Rover Sport	w/VDS 2.7 D 4x4, 3.0 D 4x4, 3.6 D 4x4, 4.2 4x4, 4.4 4x4, 5.0 4x4
L322				
A-2831			2003-2005 Range Rover	w/o VDS 3.0 D, 3.6 D, 4.2, 4.4, 4.4 D, 5.0
			2006-2012 Range Rover	w/o VDS, Incl. Supercharged 3.0 D, 3.6 D, 4.2, 4.4, 4.4 D, 5.0
			2010-2012 Range Rover	w/VDS, Incl. Supercharged 3.0 D, 3.6 D, 4.2, 4.4, 4.4 D, 5.0

LAND ROVER				
Part #	Product Type	Position	Model Information	Attributes
L322				
A-2933			2003-2005 Range Rover	w/o VDS 3.0 D, 3.6 D, 4.2, 4.4, 4.4 D, 5.0
			2006-2012 Range Rover	w/o VDS, Incl. Supercharged 3.0 D, 3.6 D, 4.2, 4.4, 4.4 D, 5.0
			2010-2012 Range Rover	w/VDS, Incl. Supercharged 3.0 D, 3.6 D, 4.2, 4.4, 4.4 D, 5.0
A-2934			2003-2005 Range Rover	w/o VDS 3.0 D, 3.6 D, 4.2, 4.4, 4.4 D, 5.0
			2006-2012 Range Rover	w/o VDS, Incl. Supercharged 3.0 D, 3.6 D, 4.2, 4.4, 4.4 D, 5.0
			2010-2012 Range Rover	w/VDS, Incl. Supercharged 3.0 D, 3.6 D, 4.2, 4.4, 4.4 D, 5.0
AS-2757			2010-2012 Range Rover	w/VDS, Incl. Supercharged 3.0 D, 3.6 D, 4.2, 4.4, 4.4 D, 5.0
AS-2758			2010-2012 Range Rover	w/VDS, Incl. Supercharged 3.0 D, 3.6 D, 4.2, 4.4, 4.4 D, 5.0
AS-2795			2006-2012 Range Rover	w/o VDS, Supercharged 3.0 D, 3.6 D, 4.2, 4.4, 4.4 D, 5.0
AS-2796			2006-2012 Range Rover	w/o VDS, Supercharged 3.0 D, 3.6 D, 4.2, 4.4, 4.4 D, 5.0
AS-2797			2010-2012 Range Rover	w/VDS, Incl. Supercharged 3.0 D, 3.6 D, 4.2, 4.4, 4.4 D, 5.0
AS-2798			2010-2012 Range Rover	w/VDS, Incl. Supercharged 3.0 D, 3.6 D, 4.2, 4.4, 4.4 D, 5.0
AS-2961			2003-2005 Range Rover	w/o VDS 3.0 D, 3.6 D, 4.2, 4.4, 4.4 D, 5.0
			2006-2012 Range Rover	w/o VDS, Incl. Supercharged 3.0 D, 3.6 D, 4.2, 4.4, 4.4 D, 5.0



ENGINEERED TO RIDE, BUILT TO LAST.®

LAND ROVER				
Part #	Product Type	Position	Model Information	Attributes
L322				
AS-2962			2003-2005 Range Rover	w/o VDS 3.0 D, 3.6 D, 4.2, 4.4, 4.4 D, 5.0
			2006-2012 Range Rover	w/o VDS, Incl. Supercharged 3.0 D, 3.6 D, 4.2, 4.4, 4.4 D, 5.0
C-2518			2003-2005 Range Rover	w/o VDS 3.0 D, 4.4
C-2967			2010-2012 Range Rover	w/VDS, Incl. Supercharged 3.0 D, 3.6 D, 4.2, 4.4, 4.4 D, 5.0
C-2989			2006-2012 Range Rover	w/o VDS, Incl. Supercharged 3.0 D, 3.6 D, 4.2, 4.4, 4.4 D, 5.0
P-2462	 OES		2003-2005 Range Rover	w/o VDS 3.0 D, 4.2, 4.4
P-3232			2006-2012 Range Rover	w/o VDS, Incl. Supercharged 3.0 D 4x4, 3.6 D 4x4, 4.2 4x4, 4.4 4x4, 4.4 D 4x4, 5.0 4x4
			2010-2012 Range Rover	w/VDS, Incl. Supercharged 3.0 D 4x4, 3.6 D 4x4, 4.2 4x4, 4.4 4x4, 4.4 D 4x4, 5.0 4x4
P-3732	 OES		2006-2012 Range Rover	w/o VDS, Incl. Supercharged 3.0 D 4x4, 3.6 D 4x4, 4.2 4x4, 4.4 4x4, 4.4 D 4x4, 5.0 4x4
			2010-2012 Range Rover	w/VDS, Incl. Supercharged 3.0 D 4x4, 3.6 D 4x4, 4.2 4x4, 4.4 4x4, 4.4 D 4x4, 5.0 4x4
RH-3378			2010-2012 Range Rover	w/VDS, Incl. Supercharged 3.0 D 4x4, 3.6 D 4x4, 4.2 4x4, 4.4 4x4, 4.4 D 4x4, 5.0 4x4
RH-3379			2010-2012 Range Rover	w/VDS, Incl. Supercharged 3.0 D 4x4, 3.6 D 4x4, 4.2 4x4, 4.4 4x4, 4.4 D 4x4, 5.0 4x4
SK-3122			2003-2005 Range Rover	w/o VDS 3.0 D, 3.6 D, 4.2, 4.4, 4.4 D, 5.0
			2006-2012 Range Rover	w/o VDS, Incl. Supercharged 3.0 D, 3.6 D, 4.2, 4.4, 4.4 D, 5.0

LAND ROVER				
Part #	Product Type	Position	Model Information	Attributes
L322				
SK-3382			2010-2012 Range Rover	w/VDS 3.0 D 4x4, 3.6 D 4x4, 4.2 4x4, 4.4 4x4/D 4x4, 5.0 4x4
L405				
A-3025			2013-2018 Range Rover	w/CVD 2.0 P400e Hybrid 4x4, 3.0 P400 MHEV 4x4/SCV6 4x4/SDV6 Hybrid 4x4/TDV6 4x4, 4.4 SDV8 4x4, 5.0 SCV8 4x4/V8 4x4
AS-3067			2013-2018 Range Rover	w/CVD 2.0 P400e Hybrid 4x4, 3.0 P400 MHEV 4x4/SCV6 4x4/SDV6 Hybrid 4x4/TDV6 4x4, 4.4 SDV8 4x4, 5.0 SCV8 4x4/V8 4x4
AS-3068			2013-2018 Range Rover	w/CVD 2.0 P400e Hybrid 4x4, 3.0 P400 MHEV 4x4/SCV6 4x4/SDV6 Hybrid 4x4/TDV6 4x4, 4.4 SDV8 4x4, 5.0 SCV8 4x4/V8 4x4
AS-3355			2013-2018 Range Rover	w/CVD 2.0 P400e Hybrid 4x4, 3.0 P400 MHEV 4x4/SCV6 4x4/SDV6 Hybrid 4x4/TDV6 4x4, 4.4 SDV8 4x4, 5.0 SCV8 4x4/V8 4x4



ARNOTT NEW SHOCK



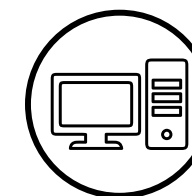





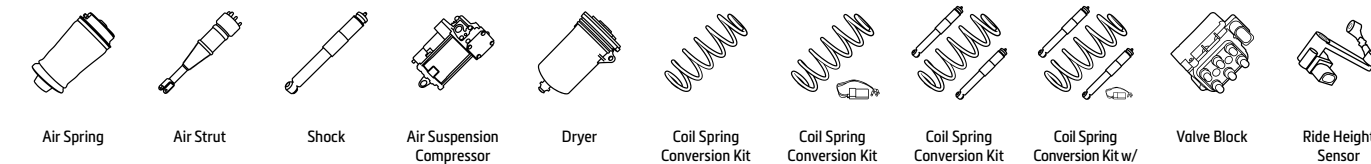

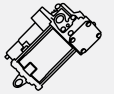

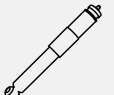

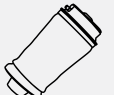



- Rear shock for 10-12 Land Rover Range Rover (w/VDS)
- New custom-tuned twin tube shock
- Protective dust boot
- New - not remanufactured, eliminates core handling
- Designed, assembled & tested in the USA
- SK-3382





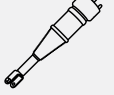

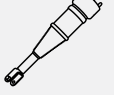



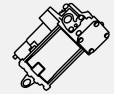







TECH TIP: SOFTWARE UPDATES

Arnott compressors for Land Rover LR3, LR4 and Range Rover Sport may need a software update after installation. Since Land Rover moved away from Hitachi to another compressor supplier, the software update is mandatory. Without this update, the compressor may not function well and this could void the warranty.





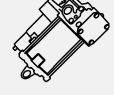

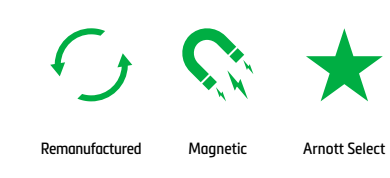
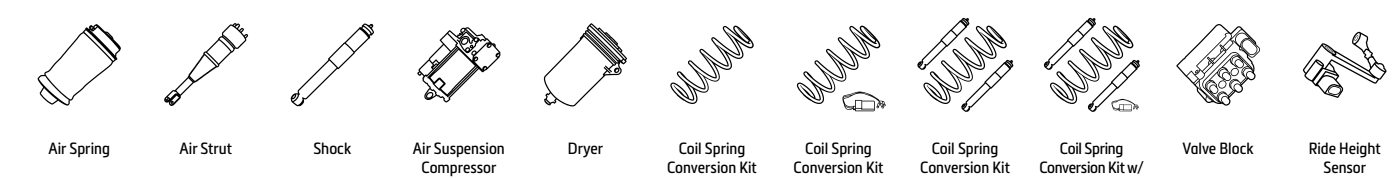



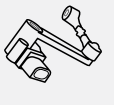

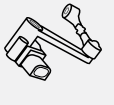

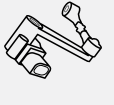



LAND ROVER				
Part #	Product Type	Position	Model Information	Attributes
L405				
P-3280			2013-2018 Range Rover	w/CVD 2.0 P400e Hybrid 4x4, 3.0 P400 MHEV 4x4/SCV6 4x4/SDV6 Hybrid 4x4/TDV6 4x4, 4.4 SDV8 4x4, 5.0 SCV8 4x4/V8 4x4
P-3731			2013-2019 Range Rover	w/CVD 2.0 P400e Hybrid 4x4, 3.0 P400 MHEV 4x4/SCV6 4x4/SDV6 Hybrid 4x4/TDV6 4x4, 4.4 SDV8 4x4, 5.0 SCV8 4x4/V8 4x4
SK-3384			2013-2019 Range Rover	w/CVD 2.0 P400e Hybrid 4x4, 3.0 P400 MHEV 4x4/SCV6 4x4/SDV6 Hybrid 4x4/TDV6 4x4, 4.4 SDV8 4x4, 5.0 SCV8 4x4/V8 4x4
L494				
A-3027			2014-2020 Range Rover Sport	w/o CVD 2.0 P400e PHEV 4x4/SD4 4x4/Si4 4x4, 3.0 P400 MHEV 4x4/SCV6 4x4/SDV6 Hybrid 4x4/TDV6 4x4, 4.4 SDV8 4x4, 5.0 SCV8 4x4
AS-3069			2014-2020 Range Rover Sport	w/o CVD 2.0 P400e PHEV 4x4/SD4 4x4/Si4 4x4, 3.0 P400 MHEV 4x4/SCV6 4x4/SDV6 Hybrid 4x4/TDV6 4x4, 4.4 SDV8 4x4, 5.0 SCV8 4x4
AS-3070			2014-2020 Range Rover Sport	w/o CVD 2.0 P400e PHEV 4x4/SD4 4x4/Si4 4x4, 3.0 P400 MHEV 4x4/SCV6 4x4/SDV6 Hybrid 4x4/TDV6 4x4, 4.4 SDV8 4x4, 5.0 SCV8 4x4
AS-3204			2014-2018 Range Rover Sport	w/CVD 2.0 SD4 4x4, 3.0 SCV6 4x4/SDV6 Hybrid 4x4/TDV6 4x4, 4.4 SDV8 4x4, 5.0 SCV8 4x4
AS-3205			2014-2018 Range Rover Sport	w/CVD 2.0 SD4 4x4, 3.0 SCV6 4x4/SDV6 Hybrid 4x4/TDV6 4x4, 4.4 SDV8 4x4, 5.0 SCV8 4x4
AS-3362			2014-2018 Range Rover Sport	w/o VDS 2.0 P400e PHEV 4x4/SD4 4x4/Si4 4x4, 3.0 P400 MHEV 4x4/SCV6 4x4/SDV6 Hybrid 4x4/TDV6 4x4, 4.4 SDV8 4x4, 5.0 SCV8 4x4
AS-3368			2014-2018 Range Rover Sport	w/VDS 2.0 P400e PHEV 4x4/SD4 4x4/Si4 4x4, 3.0 P400 MHEV 4x4/SCV6 4x4/SDV6 Hybrid 4x4/TDV6 4x4, 4.4 SDV8 4x4, 5.0 SCV8 4x4

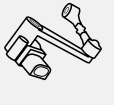

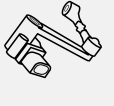

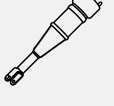



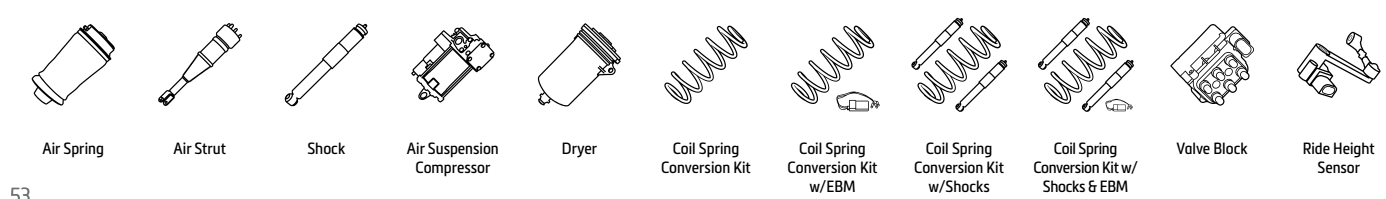





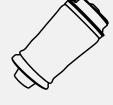

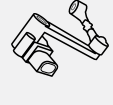

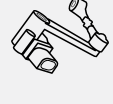

LAND ROVER				
Part #	Product Type	Position	Model Information	Attributes
L494				
P-3280			2014-2017 Range Rover Sport	w/ & w/o CVD 2.0 P400e PHEV 4x4/SD4 4x4/Si4 4x4, 3.0 P400 MHEV 4x4/SCV6 4x4/SDV6 Hybrid 4x4/TDV6 4x4, 4.4 SDV8 4x4, 5.0 SCV8 4x4
P-3731			2014-2020 Range Rover Sport	w/ & w/o CVD 2.0 P400e PHEV 4x4/SD4 4x4/Si4 4x4, 3.0 P400 MHEV 4x4/SCV6 4x4/SDV6 Hybrid 4x4/TDV6 4x4, 4.4 SDV8 4x4, 5.0 SCV8 4x4
SK-3385			2014-2019 Range Rover Sport	w/o CVD 2.0 P400e PHEV 4x4/SD4 4x4/Si4 4x4, 3.0 P400 MHEV 4x4/SCV6 4x4/SDV6 Hybrid 4x4/TDV6 4x4, 4.4 SDV8 4x4, 5.0 SCV8 4x4
SK-3386			2014-2019 Range Rover Sport	w/CVD 2.0 P400e PHEV 4x4/SD4 4x4/Si4 4x4, 3.0 P400 MHEV 4x4/SCV6 4x4/SDV6 Hybrid 4x4/TDV6 4x4, 4.4 SDV8 4x4, 5.0 SCV8 4x4
P38A				
A-2611 (Gen. II)			1995-2002 Range Rover	2.5 D, 3.9, 4.0, 4.6
A-2612 (Gen. II)			1995-2002 Range Rover	2.5 D, 3.9, 4.0, 4.6
A-2691 (Gen. III)			1995-2002 Range Rover	2.5 D, 3.9, 4.0, 4.6
A-2692 (Gen. III)			1995-2002 Range Rover	2.5 D, 3.9, 4.0, 4.6
C-2227			1995-2002 Range Rover	2.5 D, 3.9, 4.0, 4.6
P-2514			1995-2002 Range Rover	2.5 D, 3.9, 4.0, 4.6

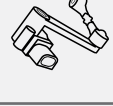

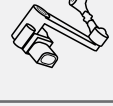

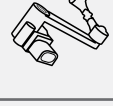

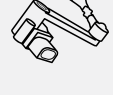



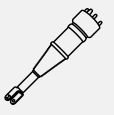

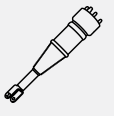

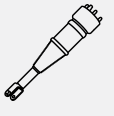

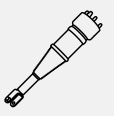

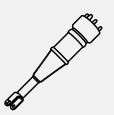

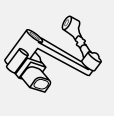

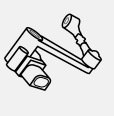

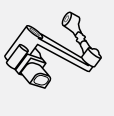
ENGINEERED TO RIDE, BUILT TO LAST.®



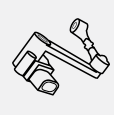

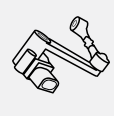





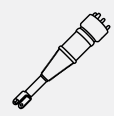

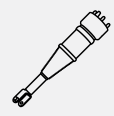
LEXUS				
Part #	Product Type	Position	Model Information	Attributes
AL10				
P-3194	 OES		2011-2015 RX 450H	450h (GYL10_) / AWD (GYL15_)
J100				
RH-3764			1998-2007 LX 470	
RH-3765			1998-2007 LX 470	
RH-3770			1998-2007 LX 470	
J120				
A-2949			2003-2009 GX 470	w/ & w/o Kinetic Dynamic Suspension UZJ120
C-2410			2003-2009 GX 470	UZJ120
P-3192	 OES		2003-2009 GX 470	UZJ120
RH-3771			2003-2009 GX 470	UZJ120
RH-3772			2003-2009 GX 470	UZJ120
SK-2812			2003-2009 GX 470	UZJ120

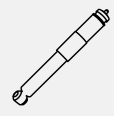

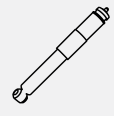
LEXUS				
Part #	Product Type	Position	Model Information	Attributes
J120				
SK-2813			2003-2009 GX 470	UZJ120
J150				
A-3331			2010-2020 GX 460	w/ & w/o Kinetic Dynamic Suspension 4WD (URJ150)
A-3332			2010-2020 GX 460	w/ & w/o Kinetic Dynamic Suspension 4WD (URJ150)
P-3191	 OES		2010-2020 GX 460	4WD (URJ150)
RH-3776			2010-2021 GX 460	4WD (URJ150)
RH-3777			2010-2021 GX 460	4WD (URJ150)
J200				
RH-3766			2008-2021 LX 570	
RH-3767			2008-2021 LX 570	
RH-3773			2008-2021 LX 570	
RH-3774			2008-2021 LX 570	
RH-3775			2013-2021 LX 570	







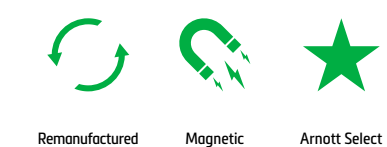
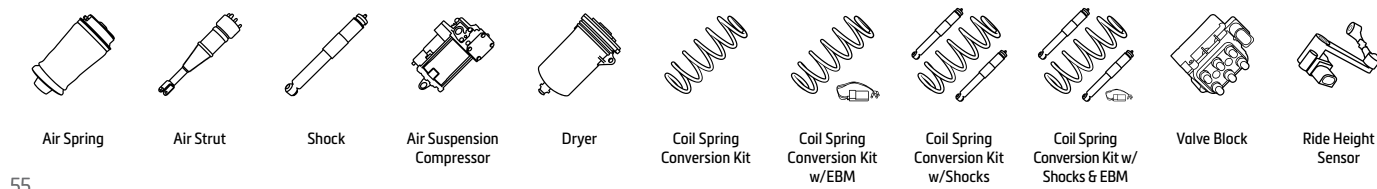





LEXUS				
Part #	Product Type	Position	Model Information	Attributes
UCF30				
AS-2894			2001-2006 LS 430	XF30
AS-3073			2001-2006 LS 430	XF30
AS-3074			2001-2006 LS 430	XF30
P-3187	 OES		2001-2006 LS 430	XF30
USF40, USF41, USF45, USF46, UVF45, UVF46				
AS-2855			2007-2017 LS 460	w/RWD, Short Wheelbase
			2007-2017 LS 460L	w/RWD, Long Wheelbase
AS-2856			2007-2012 LS 460	w/AWD or RWD, Short Wheelbase
			2007-2012 LS 460L	w/AWD or RWD, Long Wheelbase
			2008-2012 LS 600	Short Wheelbase, Hybrid
			2008-2012 LS 600h L	Long Wheelbase, Hybrid
P-3188	 OES		2007-2017 LS 460	w/AWD or RWD, Short Wheelbase
			2007-2017 LS 460L	w/AWD or RWD, Long Wheelbase
			2008-2016 LS 600	Short Wheelbase, Hybrid
			2008-2016 LS 600h L	Long Wheelbase, Hybrid
RH-3760			2007-2017 LS 460	w/RWD, Short Wheelbase
			2007-2017 LS 460L	w/RWD, Long Wheelbase
			2013-2016 LS 600h	w/RWD, Short Wheelbase
RH-3761			2007-2017 LS 460	w/RWD, Short Wheelbase
			2007-2017 LS 460L	w/RWD, Long Wheelbase
			2013-2016 LS 600h	w/RWD, Short Wheelbase
RH-3762			2007-2017 LS 460	w/AWD, Short Wheelbase
			2007-2017 LS 460L	w/AWD, Long Wheelbase
			2013-2016 LS 600h	w/AWD, Short Wheelbase

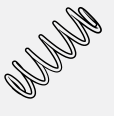



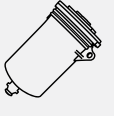
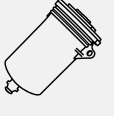
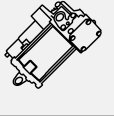
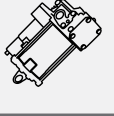

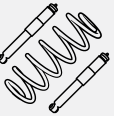



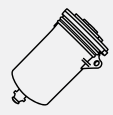
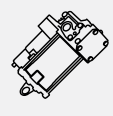
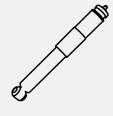

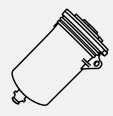
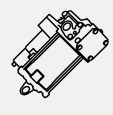

LEXUS				
Part #	Product Type	Position	Model Information	Attributes
USF40, USF41, USF45, USF46, UVF45, UVF46				
RH-3763			2007-2017 LS 460	w/AWD, Short Wheelbase
			2007-2017 LS 460L	w/AWD, Long Wheelbase
			2013-2016 LS 600h	w/AWD, Short Wheelbase
RH-3779			2007-2017 LS 460	w/AWD or RWD
			2007-2017 LS 460L	w/AWD or RWD
			2013-2016 LS 600h	w/AWD or RWD
RH-3780			2007-2017 LS 460	w/AWD or RWD
			2007-2017 LS 460L	w/AWD or RWD
			2013-2016 LS 600h	w/AWD or RWD

LINCOLN				
Part #	Product Type	Position	Model Information	Attributes
CD533				
SK-3599			2013-2016 MKZ	
SK-3600			2013-2016 MKZ	
SK-3610			2013-2016 MKZ	
SK-3611			2013-2016 MKZ	
D186				
A-2107			1984-1987 Continental	5.0 Liter V8
A-2173			1995-2002 Continental	4.6 Liter V8









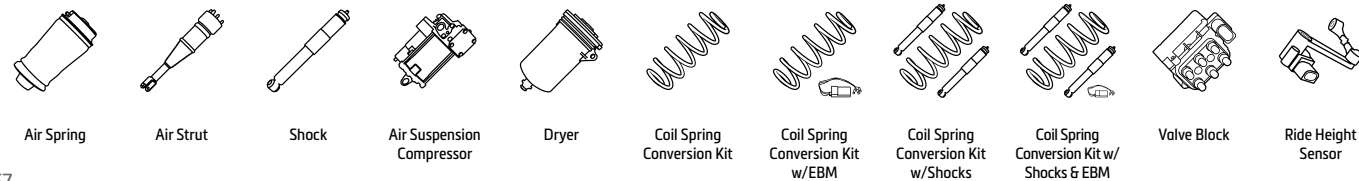

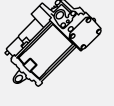
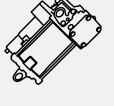





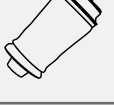

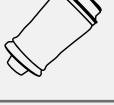



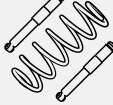

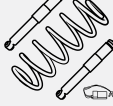

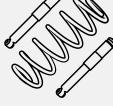
ENGINEERED TO RIDE, BUILT TO LAST.®

LINCOLN				
Part #	Product Type	Position	Model Information	Attributes
D186				
A-2174			1995-1996 Continental	4.6 Liter V8
A-2212			1995-2002 Continental	4.6 Liter V8
C-2180			1997-2002 Continental	4.6 Liter V8
C-2224			1984-1987 Continental	5.0 Liter V8
D-2155			1984-1987 Continental	5.0 Liter V8
D-2171			1995-2002 Continental	4.6 Liter V8
P-2211			1995-2002 Continental	4.6 Liter V8
P-2231			1984-1987 Continental	5.0 Liter V8
FN10				
A-2108			1993-1998 Mark VIII	4.6 Liter V8
C-2236			1993-1998 Mark VIII	4.6 Liter V8

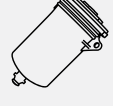
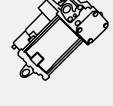
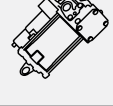
LINCOLN				
Part #	Product Type	Position	Model Information	Attributes
FN10				
D-2155			1993-1998 Mark VIII	4.6 Liter V8
P-2210			1993-1998 Mark VIII	4.6 Liter V8
SK-2225 (Sold in Pairs)			1993-1998 Mark VIII	4.6 Liter V8
Fox				
A-2107			1984-1992 Mark VII	5.0 Liter V8
C-2224			1984-1992 Mark VII	5.0 Liter V8
D-2155			1984-1992 Mark VII	5.0 Liter V8
P-2231			1984-1992 Mark VII	5.0 Liter V8
Panther				
A-2105			1990-1997 Town Car	4.6 Liter V8, 5.0 Liter V8
			1998-2011 Town Car	4.6 Liter V8
A-2220			1990-1997 Town Car	Heavy Duty for Limousine Use, 4.6 Liter V8, 5.0 Liter V8
			1998-2011 Town Car	Heavy Duty for Limousine Use, 4.6 Liter V8
C-2614			1990-1997 Town Car	4.6 Liter V8, 5.0 Liter V8
			1998-2002 Town Car	4.6 Liter V8
C-2615			2003-2011 Town Car	4.6 Liter V8

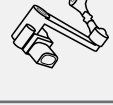





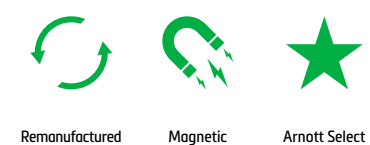
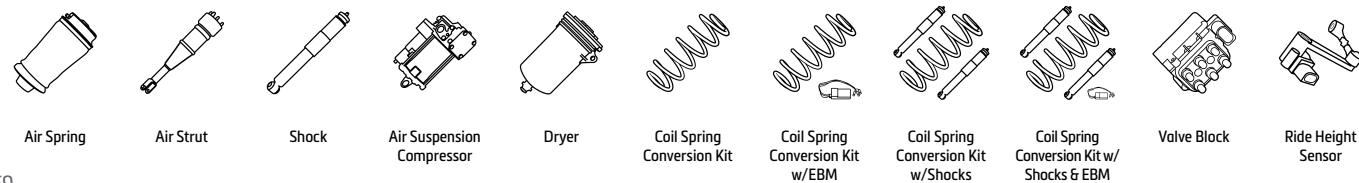



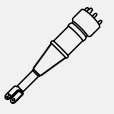

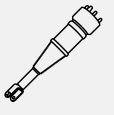
LINCOLN				
Part #	Product Type	Position	Model Information	Attributes
Panther				
D-2155			1998-2002 Town Car 4.6 Liter V8	
D-2171			1990-1997 Town Car 4.6 Liter V8, 5.0 Liter V8	
			2003-2011 Town Car 4.6 Liter V8	
P-2935			1998-2002 Town Car 4.6 Liter V8	
P-2936			1990-1997 Town Car 4.6 Liter V8, 5.0 Liter V8	
			2003-2011 Town Car 4.6 Liter V8	
U173, U228, U326				
A-2143			2003-2006 Navigator 2 Wheel Drive & 4 Wheel Drive	
A-2148			1998-2002 Navigator 2 Wheel Drive	
A-2153			1998-2002 Navigator 4 Wheel Drive	
A-2647			2007-2014 Navigator 2 Wheel Drive & 4 Wheel Drive	
A-2735			2003-2006 Navigator 2 Wheel Drive & 4 Wheel Drive	
AS-2139			2003-2006 Navigator 2 Wheel Drive & 4 Wheel Drive	

LINCOLN				
Part #	Product Type	Position	Model Information	Attributes
U173, U228, U326				
C-2140			2003-2006 Navigator 2 Wheel Drive & 4 Wheel Drive	
C-2529			2007-2014 Navigator 2 Wheel Drive & 4 Wheel Drive (AWD/RWD)	
C-2607			1998-2002 Navigator 2 Wheel Drive (RWD)	
C-2608			1998-2002 Navigator 4 Wheel Drive	
D-2155			1998-2006 Navigator 2 Wheel Drive & 4 Wheel Drive	
P-2932			1998-2006 Navigator 2 Wheel Drive & 4 Wheel Drive	
P-2937			2007-2017 Navigator 2 Wheel Drive & 4 Wheel Drive	
RH-3569			2007-2014 Expedition 2 Wheel Drive & 4 Wheel Drive	
RH-3570			2007-2014 Expedition 2 Wheel Drive & 4 Wheel Drive	
SK-2723			2003-2006 Navigator 2 Wheel Drive & 4 Wheel Drive	

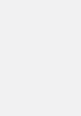
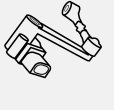

ENGINEERED TO RIDE, BUILT TO LAST.®

LINCOLN				
Part #	Product Type	Position	Model Information	Attributes
U173, U228, U326				
SK-3597			2015-2017 Navigator	2 Wheel Drive & 4 Wheel Drive
SK-3598			2015-2017 Navigator	2 Wheel Drive & 4 Wheel Drive

MAYBACH				
Part #	Product Type	Position	Model Information	Attributes
W240				
AS-2746			2003-2012 57	Base & S Models 5.5 (240.078), 6.0, 6.0 (240.079), S 6.0 (240.079, 240.077)
			2003-2012 62	Base & S Models 5.5 (240.078), 6.0, 6.0 (240.079), S 6.0 (240.079, 240.077)
AS-2747			2003-2012 57	Base & S Models 5.5 (240.078), 6.0, 6.0 (240.079), S 6.0 (240.079, 240.077)
			2003-2012 62	Base & S Models 5.5 (240.078), 6.0, 6.0 (240.079), S 6.0 (240.079, 240.077)
P-2192			2003-2012 57	Base & S Models 5.5 (240.078), 6.0, 6.0 (240.079), S 6.0 (240.079, 240.077)
			2003-2012 62	Base & S Models 5.5 (240.078), 6.0, 6.0 (240.079), S 6.0 (240.079, 240.077)
RH-3500			2003-2012 57	Base & S Models 5.5 (240.078), 6.0, 6.0 (240.079), S 6.0 (240.079, 240.077)
			2003-2012 62	Base & S Models 5.5 (240.178), 6.0 S (240.177), S 6.0 (240.179)

Arnott's multi-step remanufacturing process not only ensures that the remanufactured strut is made to our exacting standards, but includes multiple quality checks along the way.

1. Each strut is inspected, disassembled, steam cleaned and spin blasted to bare metal. Our proprietary process replaces old, used oil with new high-performance shock oil.
2. The worn internal components are replaced and the recharged shock is sealed with a new CNC-machined aluminum top.
3. Each shock is computer Dyno-tested to ensure OE durability and performance.
4. Arnott adds a protective, professional finish with corrosion-inhibiting paint and Arnott's skilled assemblers rebuild each strut by hand.
5. New, longer-lasting seals, a multi-ply name-brand air sleeve, heavy-duty crimping rings and other Tier 1 components round out the remanufacturing process.

Only the best are delivered to our customers.

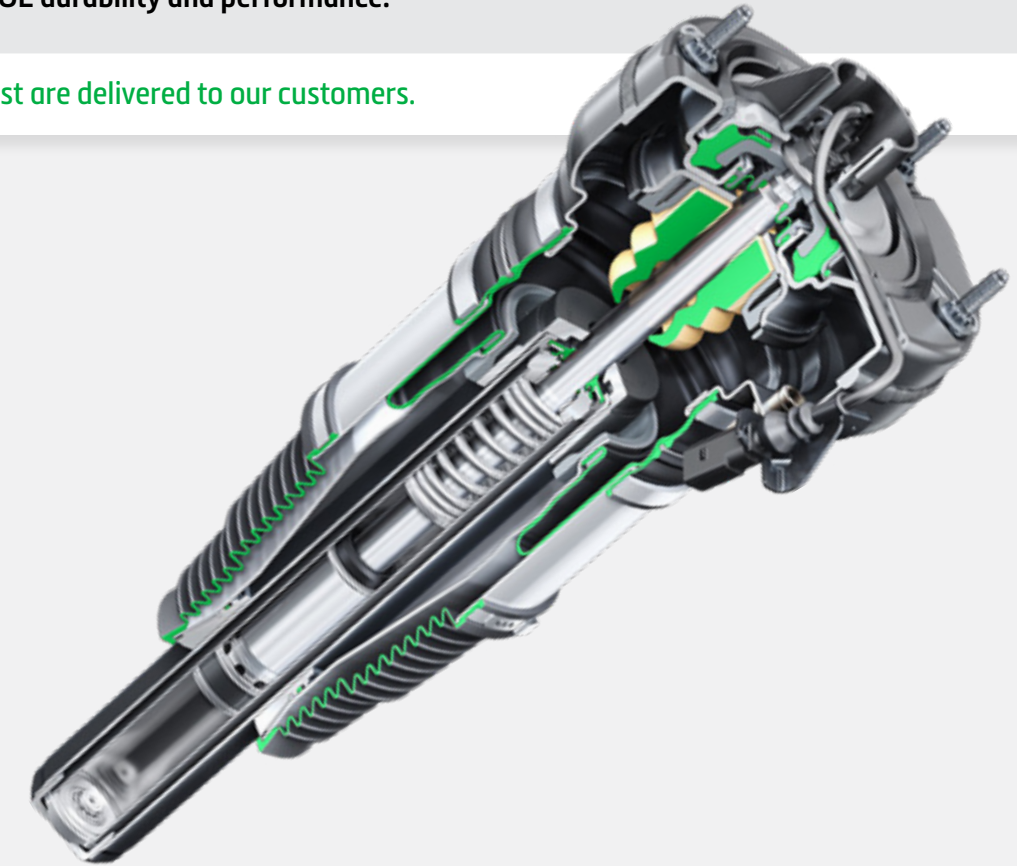









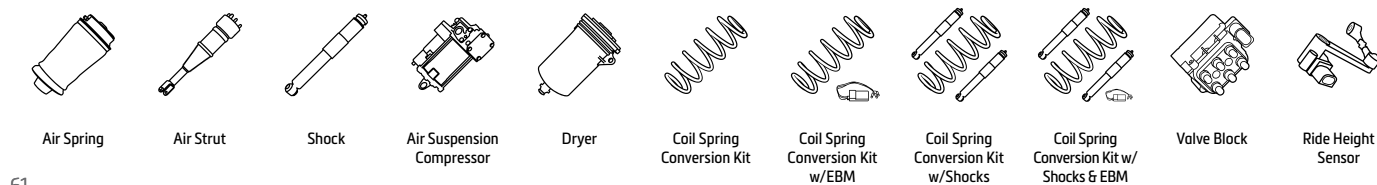

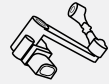





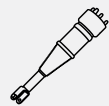

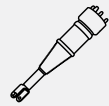

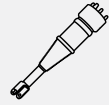
THE ARNOTT ADVANTAGE

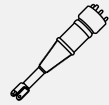
- ▲ Works with vehicle's auto damping & leveling system
- ▲ Exact fit & functionality of OE
- ▲ Arnott-engineered to improve strut longevity
- ▲ Plug & play installation is identical to OE









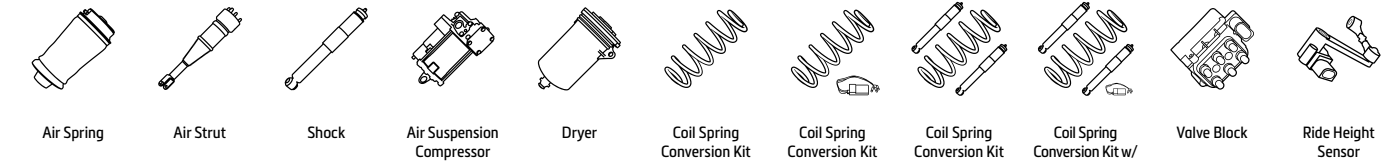

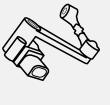

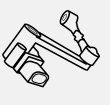





ARNOTT OFFERS REMANUFACTURED AIR STRUTS FOR:

Audi • Bentley • BMW • Cadillac • Chevrolet • GMC • Land Rover • Maybach • Mercedes-Benz
Porsche • Volkswagen



Mercedes-Benz				
Part #	Product Type	Position	Model Information	Attributes
C/W208, C209				
RH-3501			1997-2010 CLK-Class	w/LED or Bi-Xenon Intelligent Lighting Systems 200/CGI/Kompressor, 220 CDI, 230 Kompressor, 240, 270 CDI, 280, 320/CDI, 350, 430, 500, 55 AMG, 63 AMG, DTM AMG
C215, W220				
AS-2193			2000-2006 S-Class	w/AIRMATIC & ADS, w/o 4MATIC S 280, S 320/CDI, S 350, S 400 CDI, S 430, S 500, S 600
AS-2194			2000-2002 S-Class	w/AIRMATIC & ADS, w/o 4MATIC S 280, S 320/CDI, S 350/4-matic, S 400 CDI, S 430/4-matic, S 500/4-matic, S 600
			2003-2006 S-Class	w/AIRMATIC & ADS, w/ & w/o 4MATIC S 280, S 320/CDI, S 350/4-matic, S 400 CDI, S 430/4-matic, S 500/4-matic, S 600
AS-2605			2000-2006 S-Class	w/AIRMATIC & ADS, w/o 4MATIC S 280, S 320/CDI, S 350, S 400 CDI, S 430, S 500, S 600
AS-2783			2003-2006 S-Class	w/AIRMATIC & ADS, w/4MATIC S 350 4-matic, S 430 4-matic, S 500 4-matic
AS-2784			2003-2006 S-Class	w/AIRMATIC & ADS, w/4MATIC S 350 4-matic, S 430 4-matic, S 500 4-matic
AS-2884			2000-2002 S-Class	w/AIRMATIC & ADS, w/o 4MATIC S 280, S 320/CDI, S 350/4-matic, S 400 CDI, S 430/4-matic, S 500/4-matic, S 600
			2003-2006 S-Class	w/AIRMATIC & ADS, w/ & w/o 4MATIC S 280, S 320/CDI, S 350/4-matic, S 400 CDI, S 430/4-matic, S 500/4-matic, S 600
C-2242			2000-2006 S-Class	w/AIRMATIC & ADS, w/o 4MATIC S 280, S 320/CDI, S 350, S 400 CDI, S 430, S 500, S 600
C-2271			2003-2006 S-Class	w/AIRMATIC & ADS, w/4MATIC S 350 4-matic, S 430 4-matic, S 500 4-matic
C-3269			2000-2006 S-Class	w/AIRMATIC & ADS, w/o 4MATIC S 280, S 320/CDI, S 350, S 400 CDI, S 430, S 500, S 600



Mercedes-Benz				
Part #	Product Type	Position	Model Information	Attributes
C215, W220				
P-2192			2000-2002 S-Class	w/AIRMATIC & ADS, w/o 4MATIC S 280, S 320/CDI, S 350/4-matic, S 400 CDI, S 430/4-matic, S 500/4-matic, S 600
			2003-2006 S-Class	w/AIRMATIC & ADS, w/ & w/o 4MATIC S 280, S 320/CDI, S 350/4-matic, S 400 CDI, S 430/4-matic, S 500/4-matic, S 600
RH-3500			2000-2006 S-Class	w/AIRMATIC & ADS, w/o 4MATIC S 280, S 320/DI, S 350, S 400 CDI, S 430, S 500, S 55 AMG/AMG Kompressor, S 600, S 63 AMG
			2003-2006 S-Class	w/AIRMATIC & ADS, w/4MATIC S 280, S 320/DI, S 350, S 400 CDI, S 430, S 500, S 55 AMG/AMG Kompressor, S 600, S 63 AMG
RH-3501			2000-2006 CL-Class	w/LED or Bi-Xenon Intelligent Lighting Systems CL 500, CL 55 AMG/AMG Kompressor, CL 600, CL 63 AMG
			2000-2002 S-Class	w/AIRMATIC & ADS, w/o 4MATIC, w/LED or Bi-Xenon Intelligent Lighting Systems S 280, S 320/CDI, S 350/4-matic, S 400 CDI, S 430/4-matic, S 500/4-matic, S 600
			2003-2006 S-Class	w/AIRMATIC & ADS, w/ & w/o 4MATIC, w/LED or Bi-Xenon Intelligent Lighting Systems S 280, S 320/CDI, S 350/4-matic, S 400 CDI, S 430/4-matic, S 500/4-matic, S 600
SK-2458			2003-2006 CL-Class	From VIN #032562, w/ABC Suspension, AMG CL 500, CL 55 AMG/AMG Kompressor, CL 600, CL 63 AMG
			2003-2006 S-Class	From VIN #372602, w/ABC Suspension, AMG S 55 AMG/AMG Kompressor, S 600, S 63 AMG, S 65 AMG
SK-2459			2003-2006 CL-Class	From VIN #032562, w/ABC Suspension, AMG CL 500, CL 55 AMG/AMG Kompressor, CL 600, CL 63 AMG
			2003-2006 S-Class	From VIN #372602, w/ABC Suspension, AMG S 55 AMG/AMG Kompressor, S 600, S 63 AMG, S 65 AMG
SK-2460			2003-2006 CL-Class	From VIN #032562, w/ABC Suspension, AMG CL 500, CL 55 AMG/AMG Kompressor, CL 600, CL 63 AMG
			2003-2006 S-Class	From VIN #372602, w/ABC Suspension, AMG S 55 AMG/AMG Kompressor, S 600, S 63 AMG, S 65 AMG
SK-2461			2003-2006 CL-Class	From VIN #032562, w/ABC Suspension, AMG CL 500, CL 55 AMG/AMG Kompressor, CL 600, CL 63 AMG
			2003-2006 S-Class	From VIN #372602, w/ABC Suspension, AMG S 55 AMG/AMG Kompressor, S 600, S 63 AMG, S 65 AMG
C216, W221				
AS-2540			2007-2013 S-Class	w/AIRMATIC & ADS, w/o 4MATIC S 250 CDI, S 280, S 300, S 320 CDI, S 350/BlueTec/CDI/CGI, S 400 Hybrid, S 420 CDI, S 450, S 500/CGI, S 600
AS-2547			2007-2013 S-Class	w/AIRMATIC & ADS, w/4MATIC S 320 CDI 4-matic, S 350 4-matic/BlueTEC 4-matic/CGI 4-matic, S 450 4-matic, S 500 4-matic/CGI 4-matic
			2007-2014 CL-Class	w/AIRMATIC & ADS, w/4MATIC CL 500 4-matic
AS-2548			2007-2013 S-Class	w/AIRMATIC & ADS, w/4MATIC S 320 CDI 4-matic, S 350 4-matic/BlueTEC 4-matic/CGI 4-matic, S 450 4-matic, S 500 4-matic/CGI 4-matic
			2007-2014 CL-Class	w/AIRMATIC & ADS, w/4MATIC CL 500 4-matic



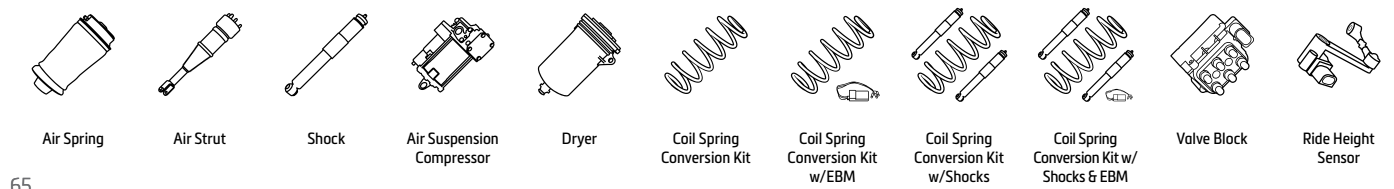



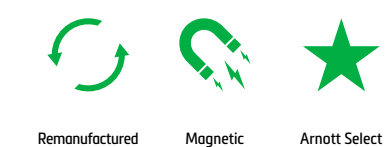













Mercedes-Benz				
Part #	Product Type	Position	Model Information	Attributes
C216, W221				
AS-2603			2007-2013 S-Class	w/AIRMATIC & ADS, w/ & w/o 4MATIC S 250 CDI, S 280, S 300, S 320 CDI/CDI 4-matic, S 350/4-matic/BlueTec/BlueTEC 4-matic/CDI/CGI/CGI 4-matic, S 400 Hybrid, S 420 CDI, S 450/4-matic, S 500/4-matic/CGI/CGI 4-matic, S 600
			2007-2014 CL-Class	w/AIRMATIC & ADS, w/ & w/o 4MATIC CL 500 4-matic
AS-2604			2007-2013 S-Class	w/AIRMATIC & ADS, w/ & w/o 4MATIC S 250 CDI, S 280, S 300, S 320 CDI/CDI 4-matic, S 350/4-matic/BlueTec/BlueTEC 4-matic/CDI/CGI/CGI 4-matic, S 400 Hybrid, S 420 CDI, S 450/4-matic, S 500/4-matic/CGI/CGI 4-matic, S 600
			2007-2014 CL-Class	w/AIRMATIC & ADS, w/ & w/o 4MATIC CL 500 4-matic
AS-2820			2007-2013 S-Class	w/AIRMATIC & ADS, w/o 4MATIC S 250 CDI, S 280, S 300, S 320 CDI, S 350/BlueTec/CDI/CGI, S 400 Hybrid, S 420 CDI, S 450, S 500/CGI, S 600
AS-2821			2007-2013 S-Class	w/AIRMATIC & ADS, w/ & w/o 4MATIC S 250 CDI, S 280, S 300, S 320 CDI/CDI 4-matic, S 350/4-matic/BlueTec/BlueTEC 4-matic/CDI/CGI/CGI 4-matic, S 400 Hybrid, S 420 CDI, S 450/4-matic, S 500/4-matic/CGI/CGI 4-matic, S 600
			2007-2014 CL-Class	w/AIRMATIC & ADS, w/ & w/o 4MATIC CL 500 4-matic
AS-2822			2007-2013 S-Class	w/AIRMATIC & ADS, w/ & w/o 4MATIC S 250 CDI, S 280, S 300, S 320 CDI/CDI 4-matic, S 350/4-matic/BlueTec/BlueTEC 4-matic/CDI/CGI/CGI 4-matic, S 400 Hybrid, S 420 CDI, S 450/4-matic, S 500/4-matic/CGI/CGI 4-matic, S 600
			2007-2014 CL-Class	w/AIRMATIC & ADS, w/ & w/o 4MATIC CL 500 4-matic
AS-2852			2007-2013 S-Class	w/AIRMATIC & ADS, w/4MATIC S 320 CDI 4-matic, S 350 4-matic/BlueTEC 4-matic/CGI 4-matic, S 450 4-matic, S 500 4-matic/CGI 4-matic
			2007-2014 CL-Class	w/AIRMATIC & ADS, w/4MATIC CL 500 4-matic
AS-2853			2007-2013 S-Class	w/AIRMATIC & ADS, w/4MATIC S 320 CDI 4-matic, S 350 4-matic/BlueTEC 4-matic/CGI 4-matic, S 450 4-matic, S 500 4-matic/CGI 4-matic
			2007-2014 CL-Class	w/AIRMATIC & ADS, w/4MATIC CL 500 4-matic
C-2609			2007-2013 S-Class	w/AIRMATIC & ADS, w/o 4MATIC S 250 CDI, S 280, S 300, S 320 CDI, S 350/BlueTec/CDI/CGI, S 400 Hybrid, S 420 CDI, S 450, S 500/CGI, S 600
C-2956			2007-2013 S-Class	w/AIRMATIC & ADS, w/4MATIC S 320 CDI 4-matic, S 350 4-matic/BlueTEC 4-matic/CGI 4-matic, S 450 4-matic, S 500 4-matic/CGI 4-matic

















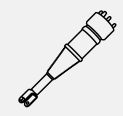

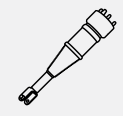

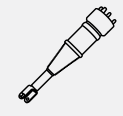
Mercedes-Benz				
Part #	Product Type	Position	Model Information	Attributes
C216, W221				
C-3271			2007-2013 S-Class	w/AIRMATIC & ADS, w/o 4MATIC S 250 CDI, S 280, S 300, S 320 CDI, S 350/BlueTec/CDI/CGI, S 400 Hybrid, S 420 CDI, S 450/CDI, S 500/CGI, S 600, S 63 AMG, S 65 AMG
C-3272			2007-2013 S-Class	w/AIRMATIC & ADS, w/4MATIC S 320 CDI 4-matic, S 350 4-matic/BlueTEC 4-matic/CGI 4-matic, S 450 4-matic, S 500 4-matic/CGI 4-matic
P-3246			2007-2013 S-Class	w/AIRMATIC & ADS, w/ & w/o 4MATIC S 250 CDI, S 280, S 300, S 320 CDI/CDI 4-matic, S 350/4-matic/BlueTec/BlueTEC 4-matic/CDI/CGI/CGI 4-matic, S 400 Hybrid, S 420 CDI, S 450/4-matic, S 500/4-matic/CGI/CGI 4-matic, S 600
			2007-2014 CL-Class	w/AIRMATIC & ADS, w/ & w/o 4MATIC CL 500 4-matic
P-3721			2007-2013 S-Class	w/AIRMATIC & ADS, w/ & w/o 4MATIC S 250 CDI, S 280, S 300, S 320 CDI/CDI 4-matic, S 350/4-matic/BlueTec/BlueTEC 4-matic/CDI/CGI/CGI 4-matic, S 400 Hybrid, S 420 CDI, S 450/4-matic, S 500/4-matic/CGI/CGI 4-matic, S 600
			2007-2014 CL-Class	w/AIRMATIC & ADS, w/ & w/o 4MATIC CL 500 4-matic
RH-3501			2007-2013 S-Class	w/AIRMATIC & ADS, w/ & w/o 4MATIC, w/LED or Bi-Xenon Intelligent Lighting Systems S 250 CDI, S 280, S 300, S 320 CDI/CDI 4-matic, S 350/4-matic/BlueTec/BlueTEC 4-matic/CDI/CGI/CGI 4-matic, S 400 Hybrid, S 420 CDI, S 450/4-matic, S 500/4-matic/CGI/CGI 4-matic, S 600
			2007-2014 CL-Class	w/AIRMATIC & ADS, w/ & w/o 4MATIC, w/LED or Bi-Xenon Intelligent Lighting Systems CL 500/4-matic, CL 600, CL 63 AMG, CL 65 AMG
VB-3267			2007-2013 S-Class	w/AIRMATIC & ADS, w/ & w/o 4MATIC S 250 CDI, S 280, S 300, S 320 CDI/CDI 4-matic, S 350/4-matic/BlueTec/BlueTEC 4-matic/CDI/CDI 4-matic/CGI/CGI 4-matic, S 400 Hybrid, S 420 CDI, S 450/4-matic/CDI, S 500/4-matic/CGI/CGI 4-matic, S 600, S 63 AMG, S 65 AMG
			2007-2014 CL-Class	w/AIRMATIC, w/ & w/o ADS, Incl. AMG
VB-3823			2007-2013 S-Class	w/AIRMATIC & ADS, w/ & w/o 4MATIC S 250 CDI, S 280, S 300, S 320 CDI/CDI 4-matic, S 350/4-matic/BlueTec/BlueTEC 4-matic/CDI/CDI 4-matic/CGI/CGI 4-matic, S 400 Hybrid, S 420 CDI, S 450/4-matic/CDI, S 500/4-matic/CGI/CGI 4-matic, S 600, S 63 AMG, S 65 AMG
			2007-2014 CL-Class	w/AIRMATIC, w/ & w/o ADS, Incl. AMG
R230				
SK-2412			2003-2006 SL-Class	w/ABC Suspension, Non-AMG 500
SK-2413			2003-2006 SL-Class	w/ABC Suspension, Non-AMG 500
SK-2414			2003-2006 SL-Class	w/ABC Suspension, Non-AMG 500

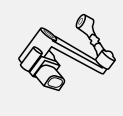

ENGINEERED TO RIDE, BUILT TO LAST.®

Mercedes-Benz				
Part #	Product Type	Position	Model Information	Attributes
R230				
SK-2415			2003-2006 SL-Class	w/ABC Suspension, Non-AMG 500
SK-2417			2003-2006 SL-Class	w/ABC Suspension, SL55/66, AMG 55 AMG/AMG Kompressor, 65 AMG
SK-2418			2003-2006 SL-Class	w/ABC Suspension, SL55/66, AMG 55 AMG/AMG Kompressor, 65 AMG
SK-2419			2003-2006 SL-Class	w/ABC Suspension, SL55/66, AMG 55 AMG/AMG Kompressor, 65 AMG
SK-2420			2003-2006 SL-Class	w/ABC Suspension, SL55/66, AMG 55 AMG/AMG Kompressor, 65 AMG
SK-2470			2007-2012 SL-Class	w/ABC Suspension, Non-AMG 600
SK-2471			2007-2012 SL-Class	w/ABC Suspension, Non-AMG 600
SK-2472			2007-2012 SL-Class	w/ABC Suspension, Non-AMG 600
SK-2473			2007-2012 SL-Class	w/ABC Suspension, Non-AMG 600
SK-2482			2007-2012 SL-Class	w/ABC Suspension, SL55/66, AMG 55 AMG/AMG Kompressor, 63 AMG, 65 AMG, 65 AMG Black Series

Mercedes-Benz				
Part #	Product Type	Position	Model Information	Attributes
R230				
SK-2483			2007-2012 SL-Class	w/ABC Suspension, SL55/66, AMG 55 AMG/AMG Kompressor, 63 AMG, 65 AMG, 65 AMG Black Series
SK-2484			2007-2012 SL-Class	w/ABC Suspension, SL55/66, AMG 55 AMG/AMG Kompressor, 63 AMG, 65 AMG, 65 AMG Black Series
SK-2485			2007-2012 SL-Class	w/ABC Suspension, SL55/66, AMG 55 AMG/AMG Kompressor, 63 AMG, 65 AMG, 65 AMG Black Series
R231				
SK-3601			2013-2019 SL-Class	Non-AMG 350, 400, 500
SK-3602			2013-2019 SL-Class	Non-AMG 350, 400, 500
SK-3627			2013-2019 SL-Class	Non-AMG 350, 400, 500
W163, W203				
RH-3501			2008-2014 C-Class	w/LED or Bi-Xenon Intelligent Lighting Systems ML 230, ML 270 CDI, ML 320, ML 350, ML 400 CDI, ML 430, ML 500, ML 55 AMG
W164, X164				
A-2575			2006-2011 ML-Class 2007-2012 GL-Class	w/AIRMATIC, w/ & w/o ADS, Incl. AMG ML 280 CDI 4-matic, ML 300 4-matic/CDI 4-matic, ML 320 CDI 4-matic, ML 350 4-matic/CDI 4-matic, ML 420 CDI 4-matic, ML 450 CDI 4-matic, ML 500 4-matic, ML 63 AMG 4-matic w/AIRMATIC, w/ & w/o ADS GL 320 CDI 4-matic/350 BlueTEC 4-matic, GL 350 CDI 4-matic, GL 420 CDI 4-matic, GL 450 4-matic/CDI 4-matic, GL 500 4-matic
A-2596			2006-2011 ML-Class 2007-2012 GL-Class	w/AIRMATIC & ADS, AMG ML 280 CDI 4-matic, ML 300 4-matic/CDI 4-matic, ML 320 CDI 4-matic, ML 350 4-matic/CDI 4-matic, ML 420 CDI 4-matic, ML 450 CDI 4-matic, ML 500 4-matic, ML 63 AMG 4-matic w/AIRMATIC, w/o ADS, Incl. AMG ML 280 CDI 4-matic, ML 300 4-matic/CDI 4-matic, ML 320 CDI 4-matic, ML 350 4-matic/CDI 4-matic, ML 420 CDI 4-matic, ML 450 CDI 4-matic, ML 500 4-matic, ML 63 AMG 4-matic w/AIRMATIC, w/ & w/o ADS GL 320 CDI 4-matic/350 BlueTEC 4-matic, GL 350 CDI 4-matic, GL 420 CDI 4-matic, GL 450 4-matic/CDI 4-matic, GL 500 4-matic

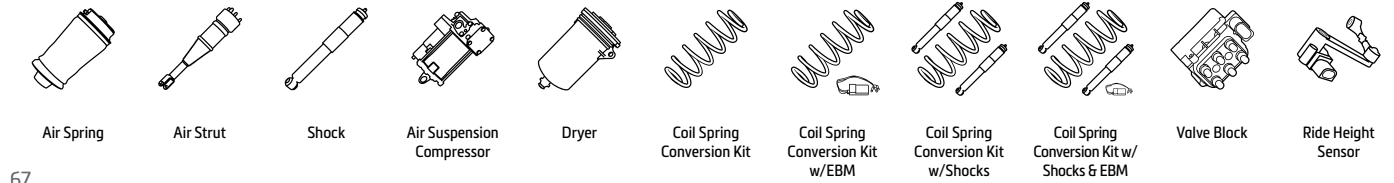





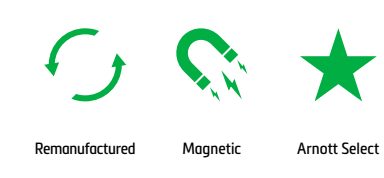
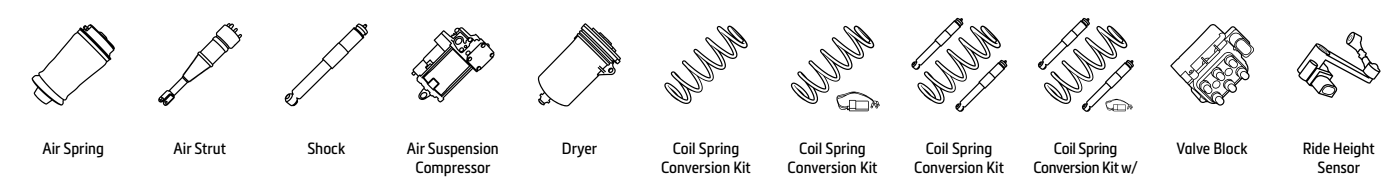



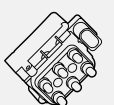





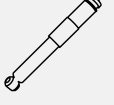

Mercedes-Benz				
Part #	Product Type	Position	Model Information	Attributes
W164, X164				
AS-2450			2006-2011 ML-Class	w/AIRMATIC & ADS, Non-AMG ML 280 CDI 4-matic, ML 300 CDI 4-matic, ML 320 CDI 4-matic, ML 350 4-matic/CDI 4-matic, ML 420 CDI 4-matic, ML 450 CDI 4-matic, ML 500 4-matic
			2007-2012 GL-Class	w/AIRMATIC & ADS GL 320 CDI 4-matic/350 BlueTEC 4-matic, GL 350 CDI 4-matic, GL 420 CDI 4-matic, GL 450 4-matic/CDI 4-matic, GL 500 4-matic
AS-2463			2006-2011 ML-Class	w/AIRMATIC & ADS, AMG ML 63 AMG 4-matic
AS-2792			2006-2011 ML-Class	w/AIRMATIC & ADS, Non-AMG ML 280 CDI 4-matic, ML 300 CDI 4-matic, ML 320 CDI 4-matic, ML 350 4-matic/CDI 4-matic, ML 420 CDI 4-matic, ML 450 CDI 4-matic, ML 500 4-matic
			2007-2012 GL-Class	w/AIRMATIC & ADS GL 320 CDI 4-matic/350 BlueTEC 4-matic, GL 350 CDI 4-matic, GL 420 CDI 4-matic, GL 450 4-matic/CDI 4-matic, GL 500 4-matic
AS-2802			2006-2011 ML-Class	w/AIRMATIC & ADS, AMG ML 63 AMG 4-matic
AS-3005			2007-2012 GL-Class	w/AIRMATIC, w/o ADS GL 320 CDI 4-matic/350 BlueTEC 4-matic, GL 350 CDI 4-matic, GL 420 CDI 4-matic, GL 450 4-matic/CDI 4-matic, GL 500 4-matic
AS-3058			2006-2011 ML-Class	w/AIRMATIC, w/o ADS, Non-AMG ML 280 CDI 4-matic, ML 300 4-matic/CDI 4-matic, ML 320 CDI 4-matic, ML 350 4-matic/CDI 4-matic, ML 420 CDI 4-matic, ML 450 CDI 4-matic, ML 500 4-matic
			2007-2012 GL-Class	w/AIRMATIC, w/o ADS GL 320 CDI 4-matic/350 BlueTEC 4-matic, GL 350 CDI 4-matic, GL 420 CDI 4-matic, GL 450 4-matic/CDI 4-matic, GL 500 4-matic
AS-3088			2006-2011 ML-Class	w/AIRMATIC & ADS, Non-AMG ML 280 CDI 4-matic, ML 300 4-matic/CDI 4-matic, ML 320 CDI 4-matic, ML 350 4-matic/CDI 4-matic, ML 420 CDI 4-matic, ML 450 CDI 4-matic, ML 500 4-matic
			2007-2012 GL-Class	w/AIRMATIC & ADS GL 320 CDI 4-matic/350 BlueTEC 4-matic, GL 350 CDI 4-matic, GL 420 CDI 4-matic, GL 450 4-matic/CDI 4-matic, GL 500 4-matic
AS-3089			2006-2011 ML-Class	w/AIRMATIC & ADS, AMG ML 63 AMG 4-matic
P-3214			2006-2011 ML-Class	w/AIRMATIC, w/ & w/o ADS, Incl. AMG ML 280 CDI 4-matic, ML 300 CDI 4-matic, ML 320 CDI 4-matic, ML 350 4-matic/CDI 4-matic, ML 420 CDI 4-matic, ML 450 CDI 4-matic, ML 500 4-matic, ML 63 AMG 4-matic
			2007-2012 GL-Class	w/AIRMATIC, w/ & w/o ADS GL 320 CDI 4-matic/350 BlueTEC 4-matic, GL 350 CDI 4-matic, GL 420 CDI 4-matic, GL 450 4-matic/CDI 4-matic, GL 500 4-matic

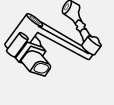

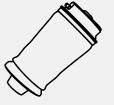





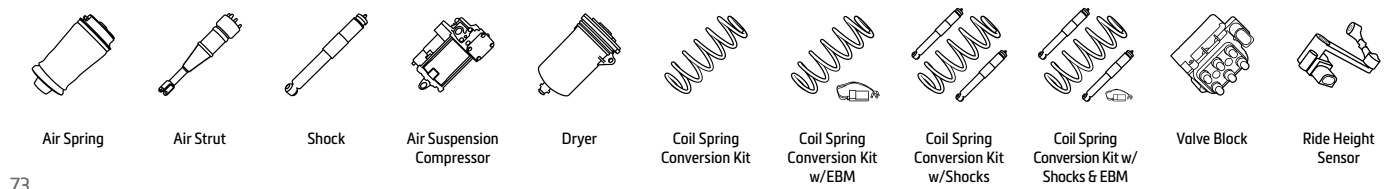











Mercedes-Benz				
Part #	Product Type	Position	Model Information	Attributes
W164, X164				
P-3722			2006-2011 ML-Class	w/AIRMATIC, w/ & w/o ADS, Incl. AMG ML 280 CDI 4-matic, ML 300 CDI 4-matic, ML 320 CDI 4-matic, ML 350 4-matic/CDI 4-matic, ML 420 CDI 4-matic, ML 450 CDI 4-matic, ML 500 4-matic, ML 63 AMG 4-matic
			2007-2012 GL-Class	w/AIRMATIC, w/ & w/o ADS GL 320 CDI 4-matic/350 BlueTEC 4-matic, GL 350 CDI 4-matic, GL 420 CDI 4-matic, GL 450 4-matic/CDI 4-matic, GL 500 4-matic
RH-3501			2006-2011 ML-Class	w/AIRMATIC, w/ & w/o ADS, w/LED or Bi-Xenon Intelligent Lighting Systems ML 280 CDI 4-matic, ML 300 4-matic/CDI 4-matic, ML 320 CDI 4-matic, ML 350 4-matic/CDI 4-matic, ML 420 CDI 4-matic, ML 450 CDI 4-matic, ML 500 4-matic, ML 63 AMG 4-matic
			2007-2012 GL-Class	w/AIRMATIC, w/ & w/o ADS, w/LED or Bi-Xenon Intelligent Lighting Systems GL 320 CDI 4-matic/350 BlueTEC 4-matic, GL 350 CDI 4-matic, GL 420 CDI 4-matic, GL 450 4-matic/CDI 4-matic, GL 500 4-matic
SK-2867			2006-2011 ML-Class	w/AIRMATIC & ADS, Non-AMG ML 280 CDI 4-matic, ML 300 CDI 4-matic, ML 320 CDI 4-matic, ML 350 4-matic/CDI 4-matic, ML 420 CDI 4-matic, ML 450 CDI 4-matic, ML 500 4-matic
			2007-2012 GL-Class	w/AIRMATIC & ADS GL 320 CDI 4-matic/350 BlueTEC 4-matic, GL 350 CDI 4-matic, GL 420 CDI 4-matic, GL 450 4-matic/CDI 4-matic, GL 500 4-matic
SK-2868			2007-2012 GL-Class	w/AIRMATIC, w/o ADS GL 320 CDI 4-matic/350 BlueTEC 4-matic, GL 350 CDI 4-matic, GL 420 CDI 4-matic, GL 450 4-matic/CDI 4-matic, GL 500 4-matic
SK-3029			2006-2011 ML-Class	w/AIRMATIC & ADS, Non-AMG ML 280 CDI 4-matic, ML 300 CDI 4-matic, ML 320 CDI 4-matic, ML 350 4-matic/CDI 4-matic, ML 420 CDI 4-matic, ML 450 CDI 4-matic, ML 500 4-matic
			2007-2012 GL-Class	w/AIRMATIC & ADS GL 320 CDI 4-matic/350 BlueTEC 4-matic, GL 350 CDI 4-matic, GL 420 CDI 4-matic, GL 450 4-matic/CDI 4-matic, GL 500 4-matic
VB-3267			2006-2011 ML-Class	w/AIRMATIC & ADS, AMG ML 280 CDI 4-matic, ML 300 4-matic/CDI 4-matic, ML 320 CDI 4-matic, ML 350 4-matic/CDI 4-matic, ML 420 CDI 4-matic, ML 450 CDI 4-matic, ML 500 4-matic, ML 63 AMG 4-matic
			2007-2012 GL-Class	w/AIRMATIC, w/o ADS, Incl. AMG ML 280 CDI 4-matic, ML 300 4-matic/CDI 4-matic, ML 320 CDI 4-matic, ML 350 4-matic/CDI 4-matic, ML 420 CDI 4-matic, ML 450 CDI 4-matic, ML 500 4-matic, ML 63 AMG 4-matic
VB-3823			2006-2011 ML-Class	w/AIRMATIC & ADS, AMG ML 280 CDI 4-matic, ML 300 4-matic/CDI 4-matic, ML 320 CDI 4-matic, ML 350 4-matic/CDI 4-matic, ML 420 CDI 4-matic, ML 450 CDI 4-matic, ML 500 4-matic, ML 63 AMG 4-matic
			2007-2012 GL-Class	w/AIRMATIC, w/o ADS, Incl. AMG ML 280 CDI 4-matic, ML 300 4-matic/CDI 4-matic, ML 320 CDI 4-matic, ML 350 4-matic/CDI 4-matic, ML 420 CDI 4-matic, ML 450 CDI 4-matic, ML 500 4-matic, ML 63 AMG 4-matic

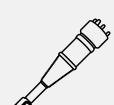

ENGINEERED TO RIDE, BUILT TO LAST.®

Mercedes-Benz				
Part #	Product Type	Position	Model Information	Attributes
W166, X166				
VB-3823			2012-2019 ML/GLE-Class	w/AIRMATIC & ADS, Incl. AMG 250 d/d 4-matic, 320 4-matic, 350 d 4-matic, 400 4-matic, 450 AMG 4-matic, 500 4-matic/e 4-matic, AMG 43 4-matic/63 4-matic/63 S 4-matic
			2013-2019 GL/GLS-Class	w/AIRMATIC, w/ & w/o ADS, Incl. AMG GL 350 CDI/BlueTec 4-matic, GL 400 4-matic, GL 500, GL 63 AMG 4-matic
W205				
A-3329			2015-2020 C-Class	w/ & w/o 4MATIC, Incl. AMG, Excl. C350e AMG C 43 4-matic/63, C 160, C 180, C 180 BlueTec/d, C 200 4-matic/BlueTec/d/EQ Boost/EQ Boost 4-matic, C 220 BlueTec/d/d 4-matic, C 250, C 250 BlueTec/d/d 4-matic, C 300, C 300 BlueTec Hybrid/h/d/d 4-matic, C 400 4-matic, C 450 AMG 4-matic
A-3330			2015-2020 C-Class	w/ & w/o 4MATIC, Incl. AMG, Excl. C350e AMG C 43 4-matic/63, C 160, C 180, C 180 BlueTec/d, C 200 4-matic/BlueTec/d/EQ Boost/EQ Boost 4-matic, C 220 BlueTec/d/d 4-matic, C 250, C 250 BlueTec/d/d 4-matic, C 300, C 300 BlueTec Hybrid/h/d/d 4-matic, C 400 4-matic, C 450 AMG 4-matic
P-3475			2015-2019 C-Class	w/AIRMATIC, w/ & w/o 4MATIC, Incl. AMG, Excl. C350e AMG C 43 4-matic/63, C 160, C 180, C 180 BlueTec/d, C 200 4-matic/BlueTec/d/EQ Boost/EQ Boost 4-matic, C 220 BlueTec/d/d 4-matic, C 250, C 250 BlueTec/d/d 4-matic, C 300, C 300 BlueTec Hybrid/h/d/d 4-matic, C 400 4-matic, C 450 AMG 4-matic
SK-3389			2015-2018 C-Class	w/AIRMATIC, w/ & w/o 4MATIC, Incl. AMG, Excl. C350e AMG C 43 4-matic/63, C 160, C 180, C 180 BlueTec/d, C 200 4-matic/BlueTec/d/EQ Boost/EQ Boost 4-matic, C 220 BlueTec/d/d 4-matic, C 250, C 250 BlueTec/d/d 4-matic, C 300, C 300 BlueTec Hybrid/h/d/d 4-matic, C 400 4-matic, C 450 AMG 4-matic
SK-3390			2015-2018 C-Class	w/AIRMATIC, w/ & w/o 4MATIC, Incl. AMG, Excl. C350e AMG C 43 4-matic/63, C 160, C 180, C 180 BlueTec/d, C 200 4-matic/BlueTec/d/EQ Boost/EQ Boost 4-matic, C 220 BlueTec/d/d 4-matic, C 250, C 250 BlueTec/d/d 4-matic, C 300, C 300 BlueTec Hybrid/h/d/d 4-matic, C 400 4-matic, C 450 AMG 4-matic
W210				
RH-3501			1996-2002 E-Class	w/LED or Bi-Xenon Intelligent Lighting Systems E 200/CDI/D/Kompressor, E 220 CDI/D, E 230, E 240, E 250 D/Turbo-D, E 270 CDI, E 280/4-matic, E 290 Turbo-D, E 300 D/Turbo-D, E 320/4-matic/CDI, E 36 AMG, E 420, E 430/4-matic, E 50 AMG/55 AMG
W211, W219				
A-2724 (Replace in Pairs)			2003-2009 E-Class	w/AIRMATIC & ADS, w/ & w/o 4MATIC, Non-AMG E 200 CDI/Kompressor/NGT, E 220 CDI, E 230, E 240/4-matic, E 270, E 280/4-matic/CDI/CDI 4-matic, E 300 BlueTEC, E 320/4-matic/CDI/CDI 4-matic, E 350/4-matic/CGI, E 400 CDI, E 420 CDI, E 500/4-matic
			2005-2011 CLS-Class	w/AIRMATIC & ADS, Non-AMG CLS 280, CLS 300, CLS 320 CDI, CLS 350/CDI, CLS 500
A-2725 (Replace in Pairs)			2003-2009 E-Class	w/AIRMATIC & ADS, AMG E 55 AMG Kompressor, E 63 AMG
			2005-2011 CLS-Class	w/AIRMATIC & ADS, AMG CLS 55 AMG, CLS 63 AMG



Mercedes-Benz				
Part #	Product Type	Position	Model Information	Attributes
W211, W219				
A-2726 (Replace in Pairs)			2003-2009 E-Class	Wagon Only, w/AIRMATIC, w/o ADS, Incl. AMG 350 CGI, E 200 CDI/Kompressor/T Kompressor, E 220 CDI/T CDI, E 230 T, E 240 T, E 270 T CDI, E 280 T/T 4-matic/T CDI/T CDI 4-matic, E 320 T/T 4-matic/T CDI/T CDI 4-matic, E 350 T, E 350 4-matic, E 500 T/T 4-matic
AS-2245			2003-2009 E-Class	w/AIRMATIC & ADS, w/o 4MATIC, Non-AMG E 200 CDI/Kompressor/NGT/T Kompressor, E 220 CDI/T CDI, E 230/T, E 240/T, E 270 CDI/T CDI, E 280/CDI/T/T CDI, E 300 BlueTEC, E 320/CDI/T CDI, E 350/CGI/T, E 400 CDI, E 420 CD, E 500/T
			2005-2011 CLS-Class	w/AIRMATIC & ADS, Non-AMG CLS 280, CLS 300, CLS 320 CDI, CLS 350/CDI, CLS 500
AS-2246			2003-2009 E-Class	w/AIRMATIC & ADS, w/o 4MATIC, Non-AMG E 200 CDI/Kompressor/NGT/T Kompressor, E 220 CDI/T CDI, E 230/T, E 240/T, E 270 CDI/T CDI, E 280/CDI/T/T CDI, E 300 BlueTEC, E 320/CDI/T CDI, E 350/CGI/T, E 400 CDI, E 420 CD, E 500/T
			2005-2011 CLS-Class	w/AIRMATIC & ADS, Non-AMG CLS 280, CLS 300, CLS 320 CDI, CLS 350/CDI, CLS 500
AS-2294			2003-2009 E-Class	w/AIRMATIC & ADS, w/4MATIC, Non-AMG E 240 4-matic/T 4-matic, E 280 4-matic/CDI 4-matic/T 4-matic/T CDI 4-matic, E 320 4-matic/CDI 4-matic/T 4-matic/T CDI 4-matic, E 350 4-matic/T 4-matic, E 500 4-matic/T 4-matic
AS-2295			2003-2009 E-Class	w/AIRMATIC & ADS, w/4MATIC, Non-AMG E 240 4-matic/T 4-matic, E 280 4-matic/CDI 4-matic/T 4-matic/T CDI 4-matic, E 320 4-matic/CDI 4-matic/T 4-matic/T CDI 4-matic, E 350 4-matic/T 4-matic, E 500 4-matic/T 4-matic
AS-2300			2003-2009 E-Class	w/AIRMATIC & ADS, AMG E 55 AMG Kompressor, E 63 AMG
			2005-2011 CLS-Class	w/AIRMATIC & ADS, AMG CLS 55 AMG, CLS 63 AMG
AS-2301			2003-2009 E-Class	w/AIRMATIC & ADS, AMG E 55 AMG Kompressor, E 63 AMG
			2005-2011 CLS-Class	w/AIRMATIC & ADS, AMG CLS 55 AMG, CLS 63 AMG
AS-2785			2003-2009 E-Class	w/AIRMATIC & ADS, w/o 4MATIC, Non-AMG E 200 CDI/Kompressor/NGT/T Kompressor, E 220 CDI/T CDI, E 230/T, E 240/T, E 270 CDI/T CDI, E 280/CDI/T/CDI, E 300 BlueTEC, E 320 CDI/T/T CDI, E 350/CGI/T, E 400 CDI, E 420 CDI, E 500/T
			2005-2011 CLS-Class	w/AIRMATIC & ADS, Non-AMG CLS 280, CLS 300, CLS 320 CDI, CLS 350/CDI, CLS 500
AS-2786			2003-2009 E-Class	w/AIRMATIC & ADS, w/o 4MATIC, Non-AMG E 200 CDI/Kompressor/NGT/T Kompressor, E 220 CDI/T CDI, E 230/T, E 240/T, E 270 CDI/T CDI, E 280/CDI/T/CDI, E 300 BlueTEC, E 320 CDI/T/T CDI, E 350/CGI/T, E 400 CDI, E 420 CDI, E 500/T
			2005-2011 CLS-Class	w/AIRMATIC & ADS, Non-AMG CLS 280, CLS 300, CLS 320 CDI, CLS 350/CDI, CLS 500
AS-2787			2003-2009 E-Class	w/AIRMATIC & ADS, AMG E 55 AMG Kompressor, E 63 AMG
			2005-2011 CLS-Class	w/AIRMATIC & ADS, AMG CLS 55 AMG, CLS 63 AMG

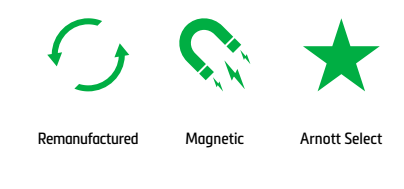





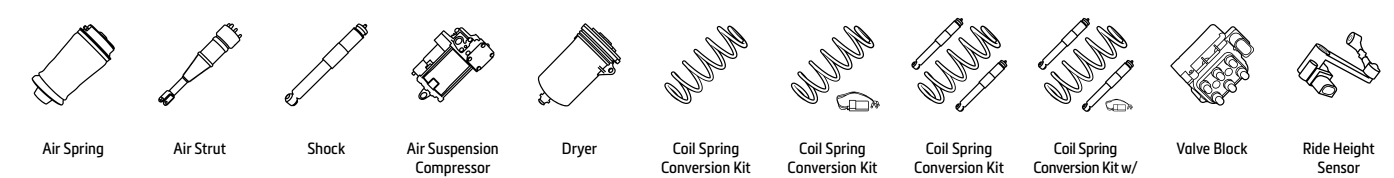























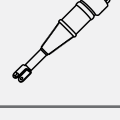

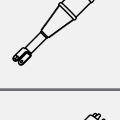
ENGINEERED TO RIDE, BUILT TO LAST.®

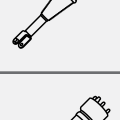
Mercedes-Benz				
Part #	Product Type	Position	Model Information	Attributes
W211, W219				
AS-2788			2003-2009 E-Class	w/AIRMATIC & ADS, AMG E 55 AMG Kompressor, E 63 AMG
			2005-2011 CLS-Class	w/AIRMATIC & ADS, AMG CLS 55 AMG, CLS 63 AMG
AS-3000			2003-2009 E-Class	w/AIRMATIC & ADS, w/4MATIC, Non-AMG E 240 4-matic/T 4-matic, E 280 4-matic/CDI 4-matic/T 4-matic/T CDI 4-matic, E 320 4-matic/CDI 4-matic/T 4-matic/T CDI 4-matic, E 350 4-matic/T 4-matic, E 500 4-matic/T 4-matic
AS-3001			2003-2009 E-Class	w/AIRMATIC & ADS, w/4MATIC, Non-AMG E 240 4-matic/T 4-matic, E 280 4-matic/CDI 4-matic/T 4-matic/T CDI 4-matic, E 320 4-matic/CDI 4-matic/T 4-matic/T CDI 4-matic, E 350 4-matic/T 4-matic, E 500 4-matic/T 4-matic
C-2278			2003-2009 E-Class	Sedan Only, w/AIRMATIC & ADS, AMG E 200 CDI/Kompressor/NGT/T Kompressor, E 220 CDI/T CDI, E 230/T, E 240/T, E 270 CDI/T CDI, E 280/CDI/T/T CDI, E 300 BlueTEC, E 320 CDI/T/T CDI, E 350/CGI/T, E 400 CDI, E 420 CDI, E 500/T
			2005-2011 CLS-Class	Sedan Only, w/AIRMATIC & ADS, w/o 4MATIC, AMG E 200 CDI/Kompressor/NGT/T Kompressor, E 220 CDI/T CDI, E 230/T, E 240/T, E 270 CDI/T CDI, E 280/CDI/T/T CDI, E 300 BlueTEC, E 320 CDI/T/T CDI, E 350/CGI/T, E 400 CDI, E 420 CDI, E 500/T
C-2663			2003-2009 E-Class	Wagon Only, w/AIRMATIC & ADS, w/4MATIC E 200 CDI/Kompressor/NGT/T Kompressor, E 220 CDI/T CDI, E 230/T, E 240/4-matic/T/T 4-matic, E 270/T CDI, E 280/4-matic/CDI/CDI 4-matic/T/T 4-matic/T CDI 4-matic, E 300 BlueTEC, E 320/4-matic/CDI/CDI 4-matic/T/T 4-matic/T CDI 4-matic, E 350/4-matic/CGI/T/T 4-matic, E 400 CDI, E 420 CDI, E 500/4-matic/T/T 4-matic
C-2896			2003-2009 E-Class	Wagon Only, w/AIRMATIC, w/o ADS, Incl. AMG 350 CGI, E 200 CDI/Kompressor/T Kompressor, E 220 CDI/T CDI, E 230 T, E 240 T, E 270 T CDI, E 280 T/T 4-matic/T CDI/T CDI 4-matic, E 320 T/T 4-matic/T CDI/T CDI 4-matic, E 350 T, E 350 4-matic, E 500 T/T 4-matic
C-3698			2003-2009 E-Class	Sedan Only, w/AIRMATIC & ADS, w/4MATIC, Incl. AMG E 240 4-matic, E 280 4-matic/CDI 4-matic, E 320 4-matic/CDI 4-matic, E 350 4-matic, E 500 4-matic

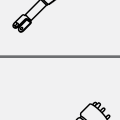



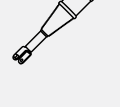



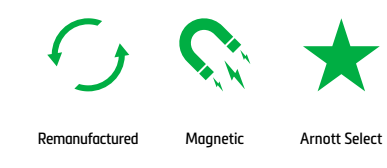
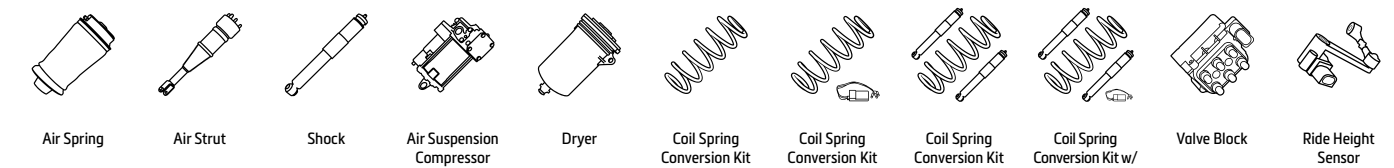





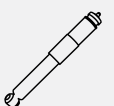

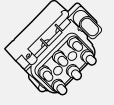
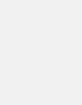
Mercedes-Benz				
Part #	Product Type	Position	Model Information	Attributes
W211, W219				
P-2192			2003-2009 E-Class	w/AIRMATIC & ADS, AMG E 200 CDI/Kompressor/NGT/T Kompressor, E 220 CDI/T CDI, E 230/T, E 240/4-matic/T/T 4-matic, E 270 CDI/T CDI, E 280/4-matic/CDI/CDI 4-matic/T/T 4-matic/T CDI 4-matic, E 300 BlueTEC, E 320/4-matic/CDI/CDI 4-matic/T/T 4-matic/T CDI 4-matic, E 350/4-matic/CGI/T/T 4-matic, E 500 T/T 4-matic, E 400 CDI, E 420 CDI, E 500/4-matic, E 55 AMG Kompressor, E 63 AMG
			2005-2011 CLS-Class	w/AIRMATIC & ADS, Incl. AMG CLS 280, CLS 300, CLS 320 CDI, CLS 350/CDI, CLS 500, CLS 55 AMG, CLS 63 AMG
RH-3500			2003-2009 E-Class	w/AIRMATIC & ADS, w/ & w/o 4MATIC, Non-AMG E 200 CDI/Kompressor/NGT, E 220 CDI, E 230, E 240/4-matic, E 270 CDI, E 280/4-matic/CDI/CDI 4-matic, E 300 BlueTEC, E 320/4-matic/CDI/CDI 4-matic, E 350/4-matic/CGI, E 400 CDI, E 420 CDI, E 500/4-matic, E 55 AMG Kompressor, E 63 AMG
			2005-2011 CLS-Class	w/AIRMATIC & ADS, Incl. AMG E 200 CDI/Kompressor/NGT, E 220 CDI, E 230, E 240/4-matic, E 270 CDI, E 280/4-matic/CDI/CDI 4-matic, E 300 BlueTEC, E 320/4-matic/CDI/CDI 4-matic, E 350/4-matic/CGI, E 400 CDI, E 420 CDI, E 500/4-matic, E 55 AMG Kompressor, E 63 AMG
RH-3501			2003-2009 E-Class	w/AIRMATIC & ADS, AMG, w/LED or Bi-Xenon Intelligent Lighting Systems E 200 CDI/Kompressor/NGT, E 220 CDI, E 230, E 240/4-matic, E 270 CDI, E 280/4-matic/CDI/CDI 4-matic, E 300 BlueTEC, E 320/4-matic/CDI/CDI 4-matic, E 350/4-matic/CGI, E 400 CDI, E 420 CDI, E 500/4-matic, E 55 AMG Kompressor, E 63 AMG
			2005-2011 CLS-Class	w/AIRMATIC & ADS, Incl. AMG, w/LED or Bi-Xenon Intelligent Lighting Systems E 200 CDI/Kompressor/NGT, E 220 CDI, E 230, E 240/4-matic, E 270 CDI, E 280/4-matic/CDI/CDI 4-matic, E 300 BlueTEC, E 320/4-matic/CDI/CDI 4-matic, E 350/4-matic/CGI, E 400 CDI, E 420 CDI, E 500/4-matic, E 55 AMG Kompressor, E 63 AMG
SK-3012			2003-2009 E-Class	Sedan Only, w/AIRMATIC & ADS, AMG E 200 CDI/Kompressor/NGT, E 220 CDI, E 230, E 240, E 270 CDI, E 280/CDI, E 300 BlueTEC, E 320/CDI, E 350/CGI, E 400 CDI, E 420 CDI, E 500, E 55 AMG Kompressor, E 63 AMG
			2005-2011 CLS-Class	Sedan Only, w/AIRMATIC & ADS, w/ & w/o 4MATIC, Non-AMG E 200 CDI/Kompressor/NGT, E 220 CDI, E 230, E 240, E 270 CDI, E 280/CDI, E 300 BlueTEC, E 320/CDI, E 350/CGI, E 400 CDI, E 420 CDI, E 500, E 55 AMG Kompressor, E 63 AMG
SK-3039			2003-2009 E-Class	w/o AIRMATIC, w/o ADS, w/ & w/o 4MATIC, Non-AMG E 200 CDI/Kompressor/NGT/CDI, E 230, E 240/4-matic, E 270 CDI, E 280/4-matic/CDI/CDI 4-matic, E 300 BlueTEC, E 320/4-matic/CDI/CDI 4-matic, E 350/4-matic/CGI, E 400 CDI, E 420 CDI, E 500/500 4-matic
			2005-2011 CLS-Class	w/o AIRMATIC, w/o ADS, Non-AMG CLS 280, CLS 300, CLS 320 CDI, CLS 350/CDI, CLS 500

Mercedes-Benz				
Part #	Product Type	Position	Model Information	Attributes
W211, W219				
SK-3197			2003-2009 E-Class	Sedan Only, w/AIRMATIC & ADS, w/o 4MATIC, Incl. AMG E 200 CDI/Kompressor/NGT, E 220 CDI/CDI, E 230, E 240, E 270 CDI, E 280/CDI, E 300 BlueTEC, E 320/CDI, E 350/CGI, E 400 CDI, E 420 CDI, E 500, E 55 AMG Kompressor, E 63 AMG
			2005-2011 CLS-Class	w/AIRMATIC & ADS, Incl. AMG CLS 280, CLS 300, CLS 320 CDI, CLS 350/CDI, CLS 500, CLS 55 AMG, CLS 63 AMG
SK-3199			2003-2009 E-Class	Sedan Only, w/AIRMATIC & ADS, w/o 4MATIC, AMG E 55 AMG Kompressor, E 63 AMG
			2005-2011 CLS-Class	w/AIRMATIC & ADS, AMG CLS 55 AMG, CLS 63 AMG
SK-3311			2003-2009 E-Class	w/o ADS E 200 CDI/Kompressor/NGT/CDI, E 230, E 240/4-matic, E 270 CDI, E 280/4-matic/CDI/CDI 4-matic, E 300 BlueTEC, E 320/4-matic/CDI/CDI 4-matic, E 350/4-matic/CGI, E 400 CDI, E 420 CDI, E 500, E 500 4-matic, E 55 AMG Kompressor, E 63 AMG
			2005-2011 CLS-Class	w/o ADS CLS 280, CLS 300, CLS 320 CDI, CLS 350/CDI, CLS 500, CLS 55 AMG, CLS 63 AMG
W212, W218				
A-2790			2010-2016 E-Class	w/AIRMATIC & ADS, w/ & w/o 4MATIC E 200, E 200 CDI/BlueTEC/CGI/NGT, E 220 BlueTEC/BlueTEC 4-matic/CDI, E 250, E 250 CDI/BlueTEC/BlueTEC 4-matic/CGI, E 300, E 300 4-matic/CDI/BlueTEC/Hybrid/BlueTEC Hybrid, E 350, E 350 4-matic/BlueTEC/BlueTEC 4-matic/CDI/CDI 4-matic/CGI, E 400, E 400 4-matic, E 500, E 500 4-matic, E 63 AMG, E 63 AMG 4-matic
			2012-2018 CLS-Class	w/AIRMATIC, w/o ADS, w/4MATIC, Non-AMG E 200, E 200 CDI/BlueTEC/CGI/NGT, E 220 BlueTEC/BlueTEC 4-matic/CDI, E 250, E 250 CDI/BlueTEC/BlueTEC 4-matic/CGI, E 300, E 300 4-matic/CDI/BlueTEC/Hybrid/BlueTEC Hybrid, E 350, E 350 4-matic/BlueTEC/BlueTEC 4-matic/CDI/CDI 4-matic/CGI, E 400, E 400 4-matic, E 500, E 500 4-matic, E 63 AMG, E 63 AMG 4-matic
A-2791			2010-2016 E-Class	w/AIRMATIC & ADS, w/ & w/o 4MATIC E 200, E 200 CDI/BlueTEC/CGI/NGT, E 220 BlueTEC/BlueTEC 4-matic/CDI, E 250, E 250 CDI/BlueTEC/BlueTEC 4-matic/CGI, E 300, E 300 4-matic/CDI/BlueTEC/Hybrid/BlueTEC Hybrid, E 350, E 350 4-matic/BlueTEC/BlueTEC 4-matic/CDI/CDI 4-matic/CGI, E 400, E 400 4-matic, E 500, E 500 4-matic, E 63 AMG, E 63 AMG 4-matic
			2012-2018 CLS-Class	w/AIRMATIC, w/ & w/o ADS, w/ & w/o 4MATIC, Incl. AMG CLS 220 BlueTEC/d, CLS 250 BlueTEC 4-matic/d 4-matic/CDI/BlueTEC/d, CLS 350/BlueTEC/d/BlueTEC 4-matic/CDI/d/CDI 4-matic/d 4-matic, CLS 400/4-matic, CLS 500/4-matic, CLS 63 AMG/AMG 4-matic
AS-3237			2010-2016 E-Class	w/AIRMATIC & ADS, w/4MATIC E 220 BlueTEC 4-matic, E 250 CDI/BlueTEC 4-matic, E 300 4-matic, E 350 BlueTEC 4-matic/CDI 4-matic, E 500 4-matic, E 63 AMG 4-matic
			2012-2018 CLS-Class	w/AIRMATIC & ADS, w/4MATIC, Incl. AMG CLS 250 BlueTEC/d 4-matic, CLS 350 BlueTEC 4-matic/CDI/d 4-matic/d 4-matic, CLS 400 4-matic, CLS 500 4-matic, CLS 63 AMG 4-matic







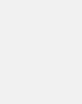

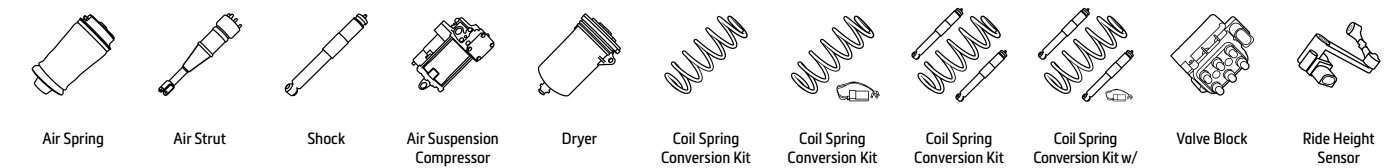









Mercedes-Benz				
Part #	Product Type	Position	Model Information	Attributes
W212, W218				
AS-3238			2010-2016 E-Class	w/AIRMATIC & ADS, w/4MATIC E 220 BlueTEC 4-matic, E 250 CDI/BlueTEC 4-matic, E 300 4-matic, E 350 BlueTEC 4-matic/CDI 4-matic, E 500 4-matic, E 63 AMG 4-matic
			2012-2018 CLS-Class	w/AIRMATIC & ADS, w/4MATIC, Incl. AMG CLS 250 BlueTEC/d 4-matic, CLS 350 BlueTEC 4-matic/CDI/d 4-matic/d 4-matic, CLS 400 4-matic, CLS 500 4-matic, CLS 63 AMG 4-matic
AS-3239			2010-2016 E-Class	w/AIRMATIC & ADS, w/o 4MATIC, Non-AMG E 180, E 200/CDI/BlueTEC/CGI/NGT, E 220 BlueTEC/CDI/BlueTEC, E 250/CDI/BlueTEC/CGI, E 300/CDI/BlueTEC/Hybrid/BlueTEC Hybrid, E 350/BlueTEC/CDI/CGI, E 400, E 500
AS-3240			2010-2016 E-Class	w/AIRMATIC & ADS, w/o 4MATIC, Non-AMG E 180, E 200/CDI/BlueTEC/CGI/NGT, E 220 BlueTEC/CDI/BlueTEC, E 250/CDI/BlueTEC/CGI, E 300/CDI/BlueTEC/Hybrid/BlueTEC Hybrid, E 350/BlueTEC/CDI/CGI, E 400, E 500
AS-3414			2012-2017 CLS-Class	w/AIRMATIC, w/o ADS, w/o 4MATIC, Incl. AMG CLS 220 BlueTEC/d, CLS 250 CDI/BlueTEC/d, CLS 350/BlueTEC/d/CDI, CLS 400, CLS 500, CLS 63 AMG
AS-3415			2012-2017 CLS-Class	w/AIRMATIC, w/o ADS, w/o 4MATIC, Incl. AMG CLS 220 BlueTEC/d, CLS 250 CDI/BlueTEC/d, CLS 350/BlueTEC/d/CDI, CLS 400, CLS 500, CLS 63 AMG
AS-3422			2010-2016 E-Class	w/AIRMATIC & ADS, w/o 4MATIC, Incl. AMG E 180, E 200/CDI/BlueTEC/CGI/NGT, E 220 BlueTEC/CDI/BlueTEC, E 250/CDI/BlueTEC/CGI, E 300/CDI/BlueTEC/Hybrid/BlueTEC Hybrid, E 350/BlueTEC/CDI/CGI, E 400, E 500, E 63 AMG
AS-3423			2010-2016 E-Class	w/AIRMATIC & ADS, w/o 4MATIC, Incl. AMG E 180, E 200/CDI/BlueTEC/CGI/NGT, E 220 BlueTEC/CDI/BlueTEC, E 250/CDI/BlueTEC/CGI, E 300/CDI/BlueTEC/Hybrid/BlueTEC Hybrid, E 350/BlueTEC/CDI/CGI, E 400, E 500, E 63 AMG
AS-3424			2010-2016 E-Class	w/AIRMATIC & ADS, w/4MATIC E 220 BlueTEC 4-matic, E 250 CDI/BlueTEC 4-matic, E 300 4-matic, E 350 4-matic/BlueTEC 4-matic/CDI 4-matic, E 400 4-matic, E 500 4-matic, E 63 AMG 4-matic
			2012-2018 CLS-Class	w/AIRMATIC & ADS, w/4MATIC, Incl. AMG CLS 250 BlueTEC 4-matic/d 4-matic, CLS 350 BlueTEC 4-matic/d 4-matic/CDI 4-matic, CLS 400 4-matic, CLS 500 4-matic, CLS 63 AMG 4-matic
AS-3425			2010-2016 E-Class	w/AIRMATIC & ADS, w/4MATIC E 220 BlueTEC 4-matic, E 250 CDI/BlueTEC 4-matic, E 300 4-matic, E 350 4-matic/BlueTEC 4-matic/CDI 4-matic, E 400 4-matic, E 500 4-matic, E 63 AMG 4-matic
			2012-2018 CLS-Class	w/AIRMATIC & ADS, w/4MATIC, Incl. AMG CLS 250 BlueTEC 4-matic/d 4-matic, CLS 350 BlueTEC 4-matic/d 4-matic/CDI 4-matic, CLS 400 4-matic, CLS 500 4-matic, CLS 63 AMG 4-matic











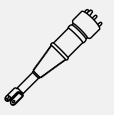





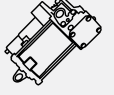

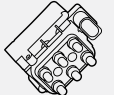
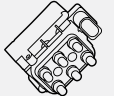
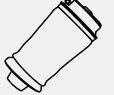

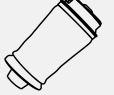

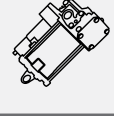
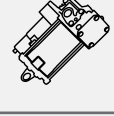

ENGINEERED TO RIDE, BUILT TO LAST.®

Mercedes-Benz				
Part #	Product Type	Position	Model Information	Attributes
W212, W218				
P-2830			2010-2016 E-Class	w/AIRMATIC & ADS, w/ & w/o 4MATIC E 200, E 200 CDI/BlueTec/CGI/NGT, E 220 BlueTec/BlueTec 4-matic/CDI, E 250, E 250 CDI/BlueTec/BlueTec 4-matic/CGI, E 300, E 300 4-matic/CDI/BlueTec/Hybrid/BlueTec Hybrid, E 350, E 350 4-matic/BlueTec/BlueTec 4-matic/CDI/CDI 4-matic/CGI, E 400, E 400 4-matic, E 500, E 500 4-matic, E 63 AMG, E 63 AMG 4-matic
			2011-2018 CLS-Class	w/AIRMATIC, w/o ADS, w/4MATIC, Non-AMG E 200, E 200 CDI/BlueTec/CGI/NGT, E 220 BlueTec/BlueTec 4-matic/CDI, E 250, E 250 CDI/BlueTec/BlueTec 4-matic/CGI, E 300, E 300 4-matic/CDI/BlueTec/Hybrid/BlueTec Hybrid, E 350, E 350 4-matic/BlueTec/BlueTec 4-matic/CDI/CDI 4-matic/CGI, E 400, E 400 4-matic, E 500, E 500 4-matic, E 63 AMG, E 63 AMG 4-matic
SK-3059			2010-2016 E-Class	w/AIRMATIC & ADS, w/ & w/o 4MATIC, Non-AMG E 200/CDI/BlueTec/CGI/NGT, E 220 BlueTec 4-matic/CDI/BlueTec, E 250/CDI/BlueTec/BlueTec 4-matic/CGI, E 300/4-matic/CDI/BlueTec/Hybrid/BlueTec Hybrid, E 350/4-matic/BlueTec/BlueTec 4-matic/CDI/CDI 4-matic/CGI, E 400/4-matic, E 500/4-matic, T-Model (E 200/CDI/BlueTec/CGI, E 220 BlueTec 4-matic/CDI/BlueTec, E 250/CDI/BlueTec/BlueTec 4-matic/CGI, E 300/4-matic/CDI/BlueTec/Hybrid/BlueTec Hybrid, E 350/4-matic/BlueTec/BlueTec 4-matic/CDI/CDI 4-matic/CGI, E 400/4-matic, E 500/4-matic)
VB-3833			2010-2016 E-Class	w/AIRMATIC, w/ & w/o ADS, w/ & w/o 4MATIC, Incl. AMG
			2012-2018 CLS-Class	w/AIRMATIC, w/ & w/o ADS, w/ & w/o 4MATIC, Incl. AMG
W213				
A-3313			2016-2020 E-Class	w/AIRMATIC, w/ & w/o 4MATIC, Incl. Hybrid, Incl. AMG AMG E 43 4-matic, AMG E 53 EQ Boost 4-matic+, AMG E 63 4-matic+/S 4-matic+, E 200/4-matic/EQ Boost/EQ Boost 4-matic/d, E 220 d 4-matic, E 250, E 300/EQ Boost/d/de/e, E 350 EQ Boost/d/d 4-matic/e, E 400 4-matic/d/d 4-matic, E 450 4-matic
A-3314			2016-2020 E-Class	w/AIRMATIC, w/ & w/o 4MATIC, Incl. Hybrid, Incl. AMG AMG E 43 4-matic, AMG E 53 EQ Boost 4-matic+, AMG E 63 4-matic+/S 4-matic+, E 200/4-matic/EQ Boost/EQ Boost 4-matic/d, E 220 d 4-matic, E 250, E 300/EQ Boost/d/de/e, E 350 EQ Boost/d/d 4-matic/e, E 400 4-matic/d/d 4-matic, E 450 4-matic
AS-3577			2016-2018 E-Class	w/AIRMATIC, w/4MATIC, E43 AMG AMG E43 4-matic
AS-3578			2016-2018 E-Class	w/AIRMATIC, w/4MATIC, E43 AMG AMG E43 4-matic
P-3475			2016-2019 E-Class	w/AIRMATIC, w/ & w/o 4MATIC, Incl. Hybrid, Incl. AMG AMG E 43 4-matic, AMG E 53 EQ Boost 4-matic+, AMG E 63 4-matic+/S 4-matic+, E 200/4-matic/EQ Boost/EQ Boost 4-matic/d, E 220 d 4-matic, E 250, E 300/EQ Boost/d/de/e, E 350 EQ Boost/d/d 4-matic/e, E 400 4-matic/d/d 4-matic, E 450 4-matic

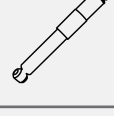

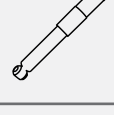

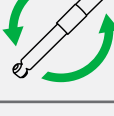



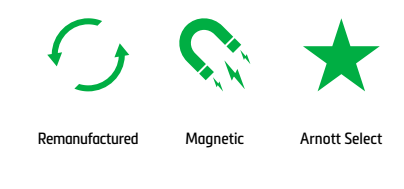
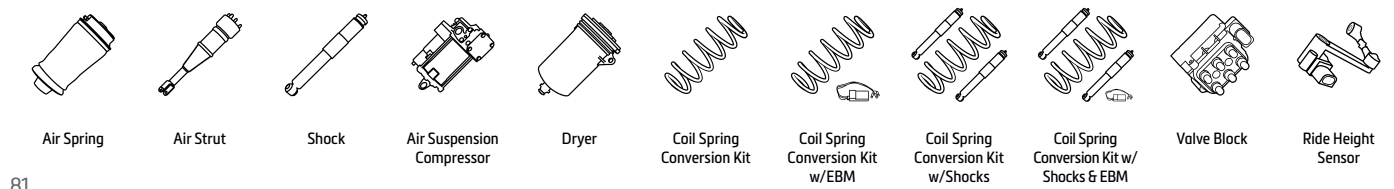

Mercedes-Benz				
Part #	Product Type	Position	Model Information	Attributes
W222				
AS-3160			2014-2020 S-Class	w/AIRMATIC, w/4MATIC, Non-AMG S 350 BlueTEC/d 4-matic/BlueTEC 4-matic, S 400 4-matic/d 4-matic, S 450 4-matic/EQ Boost 4-matic, S 500 4-matic, S 560 4-matic
			2014-2020 Maybach S 500	w/AIRMATIC, w/4MATIC, Non-AMG S 500 Maybach 4-matic, S 560 Maybach 4-matic
AS-3161			2014-2020 S-Class	w/AIRMATIC, w/4MATIC, Non-AMG S 350 BlueTEC/d 4-matic/BlueTEC 4-matic, S 400 4-matic/d 4-matic, S 450 4-matic/EQ Boost 4-matic, S 500 4-matic, S 560 4-matic
			2014-2020 Maybach S 500	w/AIRMATIC, w/4MATIC, Non-AMG S 500 Maybach 4-matic, S 560 Maybach 4-matic
AS-3162			2014-2020 S-Class	w/AIRMATIC, w/o 4MATIC, Incl. AMG S 300 BlueTEC Hybrid/h, S 350 BlueTEC/d, S 400 Hybrid/h/d, S 450 EQ Boost, S 500/EQ Boost/Hybrid/e, S 560/e, S 600
			2014-2020 Maybach S 500	w/AIRMATIC, w/o 4MATIC, Incl. AMG S 500 Maybach, S 560 Maybach, S 600 Maybach, S 650 Maybach
AS-3163			2014-2020 S-Class	w/AIRMATIC, w/o 4MATIC, Incl. AMG S 300 BlueTEC Hybrid/h, S 350 BlueTEC/d, S 400 Hybrid/h/d, S 450 EQ Boost, S 500/EQ Boost/Hybrid/e, S 560/e, S 600
			2014-2020 Maybach S 500	w/AIRMATIC, w/o 4MATIC, Incl. AMG S 300 BlueTEC Hybrid/h, S 350 BlueTEC/d, S 400 Hybrid/h/d, S 450 EQ Boost, S 500/EQ Boost/Hybrid/e, S 560/e, S 600
AS-3358			2014-2020 S-Class	w/AIRMATIC, w/o 4MATIC, Non-AMG S 300 BlueTEC Hybrid/h, S 350 BlueTEC/d/d 4-matic/BlueTEC 4-matic/d/d 4-matic, S 400 4-matic/Hybrid/h/d/d 4-matic, S 450 4-matic/EQ Boost 4-matic, S 500/4-matic/EQ Boost/Hybrid/e, S 560/4-matic/e, S 600
			2014-2020 Maybach S 500	w/AIRMATIC, w/o 4MATIC, Non-AMG S 500 Maybach/Maybach 4-matic, S 560 Maybach/Maybach 4-matic, S 600 Maybach, S 650 Maybach
AS-3359			2014-2020 S-Class	w/AIRMATIC, w/o 4MATIC, Non-AMG S 300 BlueTEC Hybrid/h, S 350 BlueTEC/d/d 4-matic/BlueTEC 4-matic/d/d 4-matic, S 400 4-matic/Hybrid/h/d/d 4-matic, S 450 4-matic/EQ Boost 4-matic, S 500/4-matic/EQ Boost/Hybrid/e, S 560/4-matic/e, S 600
			2014-2020 Maybach S 500	w/AIRMATIC, w/o 4MATIC, Non-AMG S 500 Maybach/Maybach 4-matic, S 560 Maybach/Maybach 4-matic, S 600 Maybach, S 650 Maybach
AS-3360			2014-2020 S-Class	w/AIRMATIC, w/ & w/o 4MATIC, Non-AMG S 300 BlueTEC Hybrid/h, S 350 BlueTEC/d/d 4-matic/BlueTEC 4-matic/d 4-matic, S 400 4-matic/Hybrid/h/d/d 4-matic, S 450 4-matic/EQ Boost/EQ Boost 4-matic, S 500/4-matic/EQ Boost/Hybrid/e, S 560/4-matic/e, S 600
			2014-2020 Maybach S 500	w/AIRMATIC, w/ & w/o 4MATIC, Non-AMG S 500 Maybach/Maybach 4-matic, S 560 Maybach/Maybach 4-matic, S 600 Maybach, S 650 Maybach
AS-3361			2014-2020 S-Class	w/AIRMATIC, w/ & w/o 4MATIC, Non-AMG S 300 BlueTEC Hybrid/h, S 350 BlueTEC/d/d 4-matic/BlueTEC 4-matic/d 4-matic, S 400 4-matic/Hybrid/h/d/d 4-matic, S 450 4-matic/EQ Boost/EQ Boost 4-matic, S 500/4-matic/EQ Boost/Hybrid/e, S 560/4-matic/e, S 600
			2014-2020 Maybach S 500	w/AIRMATIC, w/ & w/o 4MATIC, Non-AMG S 500 Maybach/Maybach 4-matic, S 560 Maybach/Maybach 4-matic, S 600 Maybach, S 650 Maybach
AS-3364			2014-2020 S-Class	w/AIRMATIC, w/ & w/o 4MATIC, Incl. AMG S 300 BlueTEC Hybrid/h, S 350 BlueTEC/d/d 4-matic/BlueTEC 4-matic, S 400 4-matic/Hybrid/h, S 400 d/d 4-matic, S 450 4-matic/EQ Boost/EQ Boost 4-matic, S 500/4-matic/EQ Boost/Hybrid/e, S 560/4-matic/e, S 600
			2014-2020 Maybach S 500	w/AIRMATIC, w/ & w/o 4MATIC, Incl. AMG S 500 Maybach/Maybach 4-matic, S 560 Maybach/Maybach 4-matic, S 600 Maybach, S 650 Maybach

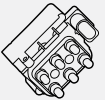



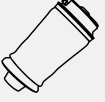

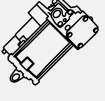
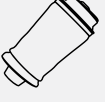

Mercedes-Benz				
Part #	Product Type	Position	Model Information	Attributes
W222				
AS-3365			2014-2020 S-Class	w/AIRMATIC, w/ & w/o 4MATIC, Incl. AMG S 300 BlueTEC Hybrid/h, S 350 BlueTEC/d/d 4-matic/BlueTEC 4-matic, S 400 4-matic/Hybrid/h, S 400 d/d 4-matic, S 450 4-matic/EQ Boost/EQ Boost 4-matic, S 500/4-matic/EQ Boost/Hybrid/e, S 560/4-matic/e, S 600
			2014-2020 Maybach S 500	w/AIRMATIC, w/ & w/o 4MATIC, Incl. AMG S 500 Maybach/Maybach 4-matic, S 560 Maybach/Maybach 4-matic, S 600 Maybach, S 650 Maybach
AS-3366			2014-2020 S-Class	w/AIRMATIC, w/4MATIC, Non-AMG S 350 BlueTEC/d 4-matic/BlueTEC 4-matic, S 400 4-matic/d 4-matic, S 450 4-matic/EQ Boost 4-matic, S 500 4-matic, S 560 4-matic
			2014-2020 Maybach S 500	w/AIRMATIC, w/4MATIC, Non-AMG S 500 Maybach 4-matic, S 560 Maybach 4-matic
AS-3367			2014-2020 S-Class	w/AIRMATIC, w/4MATIC, Non-AMG S 350 BlueTEC/d 4-matic/BlueTEC 4-matic, S 400 4-matic/d 4-matic, S 450 4-matic/EQ Boost 4-matic, S 500 4-matic, S 560 4-matic
			2014-2020 Maybach S 500	w/AIRMATIC, w/4MATIC, Non-AMG S 500 Maybach 4-matic, S 560 Maybach 4-matic
P-3282			2014-2020 S-Class	w/AIRMATIC, w/ & w/o 4MATIC, Incl. AMG S 300 BlueTEC Hybrid/h, S 350 BlueTEC/d/d 4-matic/BlueTEC 4-matic, S 400 4-matic/Hybrid/h, S 400 d/d 4-matic, S 450 4-matic/EQ Boost/EQ Boost 4-matic, S 500/4-matic/EQ Boost/Hybrid/e, S 560/4-matic/e, S 600
P-3727	 OES		2014-2020 S-Class	w/AIRMATIC, w/ & w/o 4MATIC, Incl. AMG S 300 BlueTEC Hybrid/h, S 350 BlueTEC/d/d 4-matic/BlueTEC 4-matic, S 400 4-matic/Hybrid/h, S 400 d/d 4-matic, S 450 4-matic/EQ Boost/EQ Boost 4-matic, S 500/4-matic/EQ Boost/Hybrid/e, S 560/4-matic/e, S 600
VB-3427			2014-2020 S-Class	w/ & w/o 4MATIC, Incl. AMG AMG S 63/S 63 4-matic+, S 300 BlueTEC Hybrid/h, S 350 BlueTEC/d/d 4-matic, S 400 4-matic/Hybrid/h/d/d 4-matic, S 450 4-matic/EQ Boost/EQ Boost 4-matic, S 500/4-matic/EQ Boost/Hybrid/e, S 560/4-matic/e, S 63 AMG/AMG 4-matic, S 65 AMG
			2014-2020 Maybach S 500	w/ & w/o 4MATIC, Incl. AMG S 500 Maybach/Maybach 4-matic, S 560 Maybach/Maybach 4-matic, S 600 Maybach, S 650 Maybach
VB-3823			2014-2020 S-Class	w/ & w/o 4MATIC, Incl. AMG AMG S 63/S 63 4-matic+, S 300 BlueTEC Hybrid/h, S 350 BlueTEC/d/d 4-matic, S 400 4-matic/Hybrid/h/d/d 4-matic, S 450 4-matic/EQ Boost/EQ Boost 4-matic, S 500/4-matic/EQ Boost/Hybrid/e, S 560/4-matic/e, S 63 AMG/AMG 4-matic, S 65 AMG
W251				
A-2587			2006-2013 R-Class	w/AIRMATIC & ADS, w/ & w/o 4MATIC, Incl. AMG R 280/4-matic/CDI, R 300/CDI/CDI 4-matic, R 320 CDI 4-matic, R 350/4-matic/CDI 4-matic/CGI 4-matic, R 500 4-matic, R 63 AMG 4-matic
A-2597			2006-2013 R-Class	w/AIRMATIC, w/ & w/o ADS, w/ & w/o 4MATIC, Incl. AMG R 280/4-matic/CDI, R 300/CDI/CDI 4-matic, R 320 CDI 4-matic, R 350/4-matic/CDI 4-matic/CGI 4-matic, R 500 4-matic, R 63 AMG 4-matic

Mercedes-Benz				
Part #	Product Type	Position	Model Information	Attributes
W251				
AS-2394			2006-2013 R-Class	w/AIRMATIC & ADS, w/ & w/o 4MATIC, Incl. AMG R 280/4-matic/CDI, R 300/CDI/CDI 4-matic, R 320 CDI 4-matic, R 350/4-matic/CDI 4-matic/CGI 4-matic
AS-2833			2006-2013 R-Class	w/AIRMATIC & ADS, w/ & w/o 4MATIC, Incl. AMG R 280/4-matic/CDI, R 300/CDI/CDI 4-matic, R 320 CDI 4-matic, R 350/4-matic/CDI 4-matic/CGI 4-matic, R 500 4-matic, R 63 AMG 4-matic, R 500 4-matic
P-3215			2006-2013 R-Class	w/AIRMATIC & ADS, w/ & w/o 4MATIC, Incl. AMG R 280/4-matic/CDI, R 300/CDI/CDI 4-matic, R 320 CDI 4-matic, R 350/4-matic/CDI 4-matic/CGI 4-matic, R 500 4-matic, R 63 AMG 4-matic
P-3281			2006-2013 R-Class	w/AIRMATIC, w/ & w/o ADS, w/ & w/o 4MATIC, Incl. AMG R 280/4-matic/CDI, R 300/CDI/CDI 4-matic, R 320 CDI 4-matic, R 350/4-matic/CDI 4-matic/CGI 4-matic, R 500 4-matic, R 63 AMG 4-matic
P-3724	 OES		2006-2013 R-Class	w/AIRMATIC, w/ & w/o ADS, w/ & w/o 4MATIC, Incl. AMG R 280/4-matic/CDI, R 300/CDI/CDI 4-matic, R 320 CDI 4-matic, R 350/4-matic/CDI 4-matic/CGI 4-matic, R 500 4-matic, R 63 AMG 4-matic
P-3725	 OES		2006-2013 R-Class	w/AIRMATIC & ADS, w/ & w/o 4MATIC, Incl. AMG R 280/4-matic/CDI, R 300/CDI/CDI 4-matic, R 320 CDI 4-matic, R 350/4-matic/CDI 4-matic/CGI 4-matic, R 500 4-matic, R 63 AMG 4-matic
SK-3217			2006-2013 R-Class	w/AIRMATIC & ADS, w/ & w/o 4MATIC, Non-AMG R 320 CDI 4-matic, R 350/4-matic/CDI 4-matic/CGI 4-matic, R 500 4-matic
SK-3218			2006-2013 R-Class	w/o AIRMATIC, w/ & w/o 4MATIC, Incl. AMG R 320 CDI 4-matic, R 350/4-matic/CDI 4-matic/CGI 4-matic, R 500 4-matic
SK-3262			2006-2013 R-Class	w/AIRMATIC & ADS, w/4MATIC, Non-AMG R 280/4-matic/CDI, R 300/CDI/CDI 4-matic, R 320 CDI 4-matic, R 350/4-matic/CDI 4-matic/CGI 4-matic, R 500 4-matic
VB-3267			2010-2012 R-Class	w/AIRMATIC, w/ & w/o ADS, w/ & w/o 4MATIC, Incl. AMG R 350 CDI 4-matic

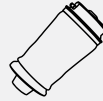

ENGINEERED TO RIDE, BUILT TO LAST.®

Mercedes-Benz				
Part #	Product Type	Position	Model Information	Attributes
W251				
VB-3823			2006-2013 R-Class	w/AIRMATIC, w/ & w/o ADS, w/ & w/o 4MATIC, Incl. AMG R 350 CDI 4-matic
VB-3499			2006-2012 R-Class	w/o AIRMATIC, w/ & w/o 4MATIC, Incl. AMG R 280/CDI/CDI 4-matic, R 300/CDI/CDI 4-matic, R 320 CDI 4-matic, R 350/4-matic/CDI 4-matic/CGI 4-matic, R 500 4-matic
W257				
A-3313			2019-2020 CLS-Class	w/AIRMATIC, w/ & w/o 4MATIC, Incl. Hybrid, Incl. AMG AMG CLS 53 EQ Boost 4-matic+, CLS 220 d, CLS 300 d, CLS 350 EQ Boost/EQ Boost 4-matic/d/d 4-matic, CLS 400 d 4-matic, CLS 450 EQ Boost 4-matic
A-3314			2019-2020 CLS-Class	w/AIRMATIC, w/ & w/o 4MATIC, Incl. Hybrid, Incl. AMG AMG CLS 53 EQ Boost 4-matic+, CLS 220 d, CLS 300 d, CLS 350 EQ Boost/EQ Boost 4-matic/d/d 4-matic, CLS 400 d 4-matic, CLS 450 EQ Boost 4-matic
W638				
P-2219			1996-2003 V-Class	V 200, V 200 CDI, V 220 CDI, V 230, V 230 TD, V 280
W639				
A-2801			2004-2014 V-Class	3.0, 3.2, 3.5, 3.7, CDI 2.0/4-matic, CDI 2.2/4-matic, CDI 3.0
P-3726			2004-2014 V-Class	3.0, 3.2, 3.5, 3.7, CDI 2.0/4-matic, CDI 2.2/4-matic, CDI 3.0

Mercedes-Benz				
Part #	Product Type	Position	Model Information	Attributes
X/C253				
A-3313			2016-2020 GLC-Class	w/AIRMATIC, w/ & w/o 4MATIC, Incl. Hybrid, Incl. AMG 200 EQ Boost/EQ Boost 4-matic/d/d 4-matic, 220 d/d 4-matic, 250 4-matic/d 4-matic, 300 4-matic/EQ Boost 4-matic/d 4-matic, 350 d 4-matic/e 4-matic, 400 d 4-matic, AMG 43 4-matic, AMG 63 4-matic+/S 4-matic+
A-3314			2016-2020 GLC-Class	w/AIRMATIC, w/ & w/o 4MATIC, Incl. Hybrid, Incl. AMG 200 EQ Boost/EQ Boost 4-matic/d/d 4-matic, 220 d/d 4-matic, 250 4-matic/d 4-matic, 300 4-matic/EQ Boost 4-matic/d 4-matic, 350 d 4-matic/e 4-matic, 400 d 4-matic, AMG 43 4-matic, AMG 63 4-matic+/S 4-matic+
AS-3579			2016-2019 GLC-Class 2016-2019 GLC-Class Coupe	w/AIRMATIC, w/ & w/o 4MATIC, Incl. Hybrid, AMG AMG 43 4-matic, AMG 63 4-matic+/S 4-matic+
AS-3580			2016-2019 GLC-Class 2016-2019 GLC-Class Coupe	w/AIRMATIC, w/ & w/o 4MATIC, Incl. Hybrid, AMG AMG 43 4-matic, AMG 63 4-matic+/S 4-matic+
P-3475			2016-2019 GLC-Class	w/AIRMATIC, w/ & w/o 4MATIC, Incl. Hybrid, Incl. AMG 200 EQ Boost/EQ Boost 4-matic/d/d 4-matic, 220 d/d 4-matic, 250 4-matic/d 4-matic, 300 4-matic/EQ Boost 4-matic/d 4-matic, 350 d 4-matic/e 4-matic, 400 d 4-matic, AMG 43 4-matic, AMG 63 4-matic+/S 4-matic+

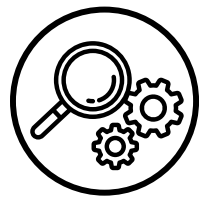





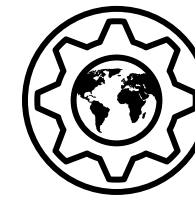
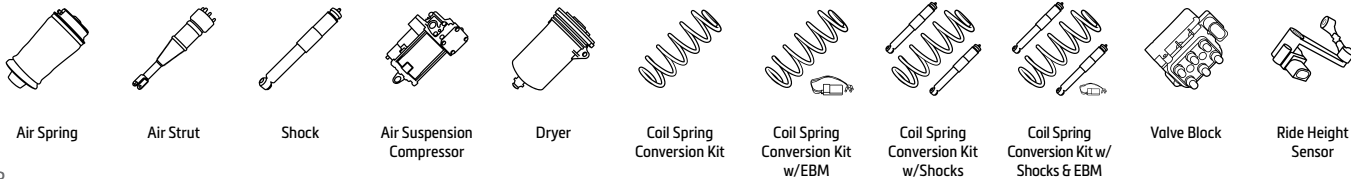



Arnott's Quality Assurance Team is part of the process from development to production. At every step, they make sure that Arnott's high standards of quality, engineering and manufacturing are maintained.

Comprehensive Quality Assurance

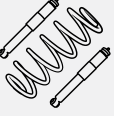

World-Class R&D

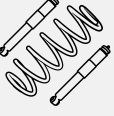
Arnott's engineers study countless of cores and then strive to improve upon OE product failure points. From shock testing machines to 3D printers to real world testing on company owned vehicles, Arnott is able to provide advanced solutions for today's air suspension replacement needs.

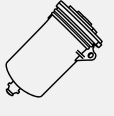
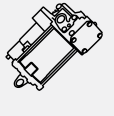
Mercury				
Part #	Product Type	Position	Model Information	Attributes
Panther				
A-2105			1992-2011 Grand Marquis	4.6 Liter V8
A-2220			1992-2011 Grand Marquis	Heavy Duty for Limousine Use, 4.6 Liter V8
C-2614			1992-2002 Grand Marquis	4.6 Liter V8
C-2615			2003-2011 Grand Marquis	4.6 Liter V8
D-2171			1992-2011 Grand Marquis	4.6 Liter V8
P-2936			1992-2011 Grand Marquis	4.6 Liter V8



Quality Checked

Arnott computer-tests remanufactured shocks and struts as well as compressors for durability and OE functionality.

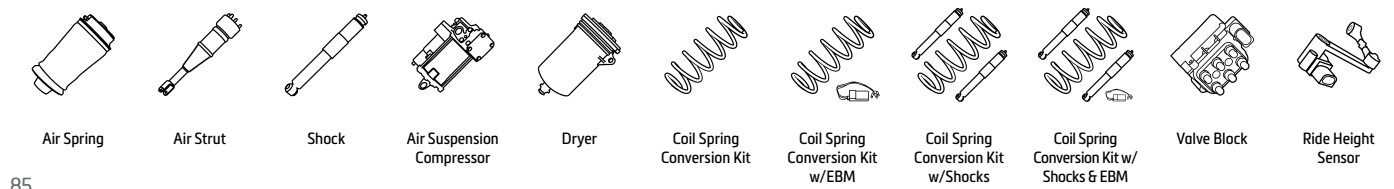

Air suspension compressors inflate or deflate air spring bags to maintain a vehicle's factory designated height. Compressor burnout is one of the most frequent air suspension system problems and is often due to overuse caused by leaking air springs or air struts. When the vehicle is not at the correct height due to leaks in the system, the compressor repeatedly cycles to maintain pressure - ultimately leading to its failure.

Arnott's compressors are direct OE replacements and are vigorously tested to ensure a long life and reduced failure rates.

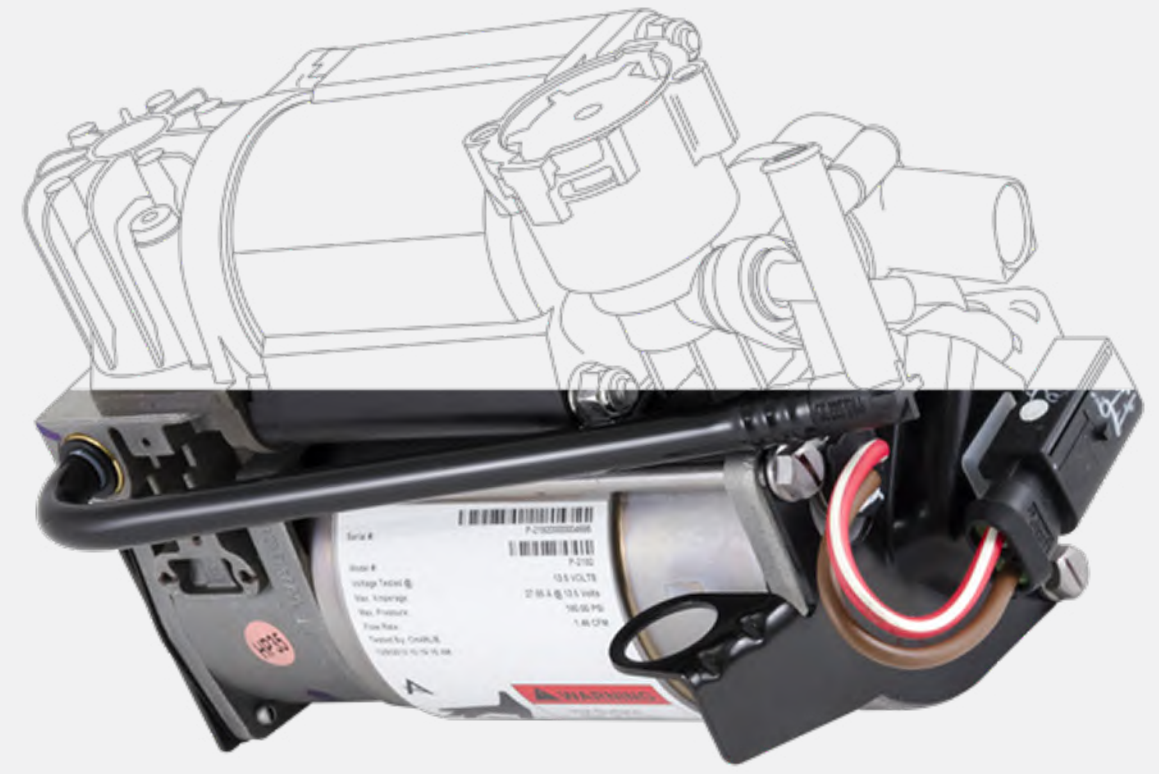













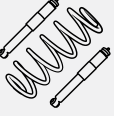

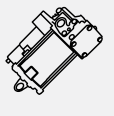
THE ARNOTT ADVANTAGE

- ▲ Meets OE specifications
- ▲ Electrocoated epoxy finish to prevent corrosion
- ▲ Maintenance-free integrated air dryers
- ▲ Most Arnott compressors are fully assembled, including application-specific air lines, wiring harness & brackets
- ▲ Assembled & tested in the USA
- ▲ Includes thermal overload protection
- ▲ Fast, flawless plug & play installation





ARNOTT OFFERS AIR SUSPENSION COMPRESSORS FOR:

Audi • Bentley • BMW • Buick • Cadillac • Chevrolet • Citroën • Ford • GMC • Infiniti • Jaguar • Jeep
 Lamborghini • Land Rover • Lexus • Lincoln • Maybach • Mercedes-Benz • Mercury • Nissan • Oldsmobile
 Peugeot • Porsche • Ram • Tesla • Toyota • Volkswagen • Volvo

NISSAN				
Part #	Product Type	Position	Model Information	Attributes
WA60				
AS-3284			2005-2015 Armada	4 Wheel Drive 5.6 4x4
C-3421			2005-2015 Armada	4 Wheel Drive 5.6 4x4
C-3434			2005-2015 Armada	RWD 5.6
P-3277			2005-2015 Armada	4 Wheel Drive & RWD 5.6, 5.6 4x4

OLDSMOBILE				
Part #	Product Type	Position	Model Information	Attributes
G Platform				
AS-2190 (Sold in Pairs)			1995-2003 Aurora	
SK-2189 (Sold in Pairs)			1998-2003 Aurora	
GMT360				
A-2610 (Gen. II)			2002-2004 Bravada	
C-2137			2002-2004 Bravada	

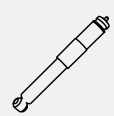
PEUGEOT				
Part #	Product Type	Position	Model Information	Attributes
VF3X_				
P-2851	 OES		2007-2011 Expert	1.6 HDi 90 16V/8V, 2.0 16V/HDi 120/HDi 120 4x4/HDi 140/HDi 165

PONTIAC				
Part #	Product Type	Position	Model Information	Attributes
G Platform				
AS-2190 (Sold in Pairs)			2000-2004 Bonneville	
SK-2189 (Sold in Pairs)			2000-2004 Bonneville	

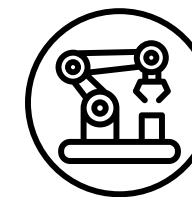





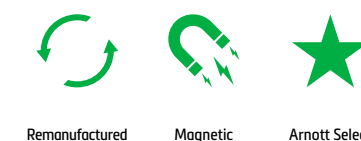
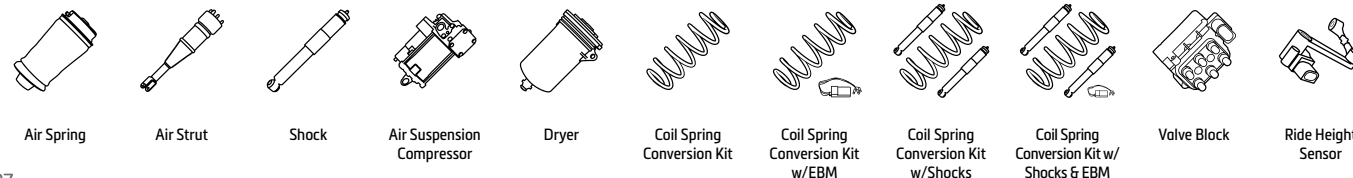





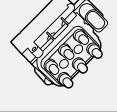

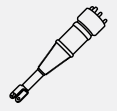

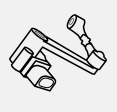

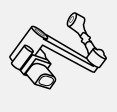







**Precision
Production**

Our precise production processes ensure the highest quality products are built every time, and that our discerning customers only receive the best parts for their vehicles. With facilities in North America and Europe, Arnott has over 300,000 square feet of manufacturing floor space which includes multiple 5-Axis CNC machines, advanced recharging stations, automated painting, and state of the art warehousing.

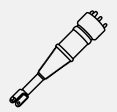

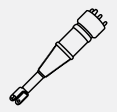

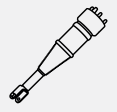



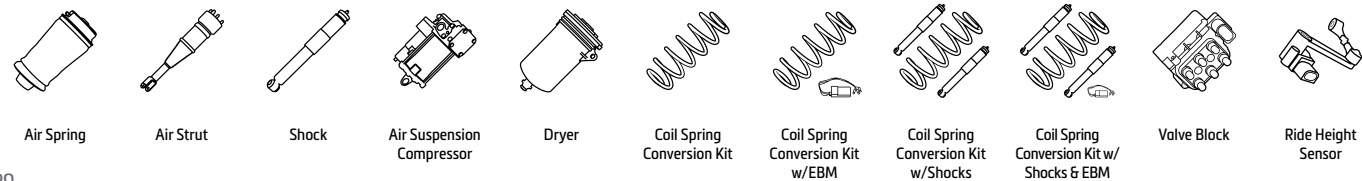

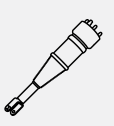

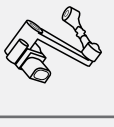

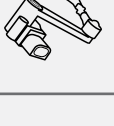

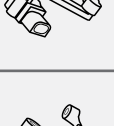





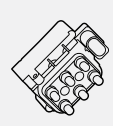

ENGINEERED TO RIDE, BUILT TO LAST.®

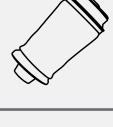
PORSCHÉ				
Part #	Product Type	Position	Model Information	Attributes
92A				
AS-3056			2011-2018 Cayenne	w/Auto-Leveling 3.0 Diesel/S E-Hybrid, 3.6, 3.6 GTS/S, 4.2 S Diesel, 4.8 GTS/S/Turbo/Turbo S
AS-3057			2011-2018 Cayenne	w/Auto-Leveling 3.0 Diesel/S E-Hybrid, 3.6, 3.6 GTS/S, 4.2 S Diesel, 4.8 GTS/S/Turbo/Turbo S
AS-3166			2011-2018 Cayenne	w/Auto-Leveling 3.0 Diesel/S E-Hybrid, 3.6, 3.6 GTS/S, 4.2 S Diesel, 4.8 GTS/S/Turbo/Turbo S
AS-3167			2011-2018 Cayenne	w/Auto-Leveling 3.0 Diesel/S E-Hybrid, 3.6, 3.6 GTS/S, 4.2 S Diesel, 4.8 GTS/S/Turbo/Turbo S
AS-3235			2011-2018 Cayenne	w/Auto-Leveling 3.0 Diesel/S E-Hybrid, 3.6, 3.6 GTS/S, 4.2 S Diesel, 4.8 GTS/S/Turbo/Turbo S
AS-3236			2011-2018 Cayenne	w/Auto-Leveling 3.0 Diesel/S E-Hybrid, 3.6, 3.6 GTS/S, 4.2 S Diesel, 4.8 GTS/S/Turbo/Turbo S
VB-3470			2011-2018 Cayenne	w/Auto-Leveling 3.0 Diesel/S E-Hybrid, 3.6, 3.6 GTS/S, 4.2 S Diesel, 4.8 GTS/S/Turbo/Turbo S
VB-3824			2011-2018 Cayenne	w/Auto-Leveling 3.0 Diesel/S E-Hybrid, 3.6, 3.6 GTS/S, 4.2 S Diesel, 4.8 GTS/S/Turbo/Turbo S
95B				
A-3327			2015-2018 Macan	w/Auto-Leveling 2.0, 3.0 GTS/S/S Diesel, 3.6 Turbo
A-3328			2015-2018 Macan	w/Auto-Leveling 2.0, 3.0 GTS/S/S Diesel, 3.6 Turbo

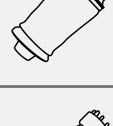
PORSCHÉ				
Part #	Product Type	Position	Model Information	Attributes
95B				
AS-3351			2015-2018 Macan	w/Auto-Leveling 2.0, 3.0 GTS/S/S Diesel, 3.6 Turbo
RH-3459			2015-2020 Macan	2.0, 3.0 GTS/S/S Diesel, 3.6 Turbo
RH-3460			2015-2020 Macan	2.0, 3.0 GTS/S/S Diesel, 3.6 Turbo
970				
A-3306			2010-2016 Panamera	3.0 4S/D/S/S E-Hybrid, 3.6/4, 4.8 4S/GTS/S/Turbo/Turbo S
AS-3035			2010-2013 Panamera	3.0 D/S E-Hybrid, 3.6, 3.6 4, 4.8 4S/GTS/S/Turbo/Turbo S
AS-3036			2010-2013 Panamera	3.0 D/S E-Hybrid, 3.6, 3.6 4, 4.8 4S/GTS/S/Turbo/Turbo S
AS-3037			2014-2016 Panamera	3.0 4S/D/S/S E-Hybrid, 3.6, 3.6 4, 4.8 GTS/Turbo/Turbo S
AS-3038			2014-2016 Panamera	3.0 4S/D/S/S E-Hybrid, 3.6, 3.6 4, 4.8 GTS/Turbo/Turbo S
AS-3345			2010-2013 Panamera	w/ & w/o AWD 3.0 D/S E-Hybrid, 3.6, 3.6 4, 4.8 4S/GTS/S/Turbo/Turbo S
AS-3346			2010-2013 Panamera	w/ & w/o AWD 3.0 D/S E-Hybrid, 3.6, 3.6 4, 4.8 4S/GTS/S/Turbo/Turbo S
AS-3376			2014-2016 Panamera	3.0 4S/D/S/S E-Hybrid, 3.6, 3.6 4, 4.8 GTS/Turbo/Turbo S

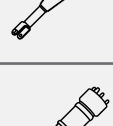

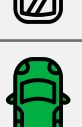
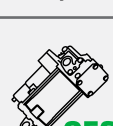
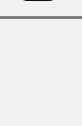
PORSCHE				
Part #	Product Type	Position	Model Information	Attributes
970				
AS-3377			2014-2016 Panamera	3.0 4S/D/S/S E-Hybrid, 3.6, 3.6 4, 4.8 GTS/Turbo/Turbo S
RH-3714			2010-2016 Panamera	3.0 4S/D/S/S E-Hybrid, 3.6/4, 4.8 4S/GTS/S/Turbo/Turbo S
RH-3715			2010-2016 Panamera	3.0 4S/D/S/S E-Hybrid, 3.6/4, 4.8 4S/GTS/S/Turbo/Turbo S
RH-3716			2010-2016 Panamera	3.0 4S/D/S/S E-Hybrid, 3.6/4, 4.8 4S/GTS/S/Turbo/Turbo S
RH-3717			2010-2016 Panamera	3.0 4S/D/S/S E-Hybrid, 3.6/4, 4.8 4S/GTS/S/Turbo/Turbo S

PORSCHE				
Part #	Product Type	Position	Model Information	Attributes
970				
VB-3470			2010-2016 Panamera	Excl. Hybrid 3.0 4S/D/S/S E-Hybrid, 3.6/4, 4.8 4S/GTS/S/Turbo/Turbo S
VB-3824			2010-2016 Panamera	3.0 4S/D/S/S E-Hybrid, 3.6/4, 4.8 4S/GTS/S/Turbo/Turbo S
971				
P-3477	 OES		2017-2021 Panamera	2.9 4 E-Hybrid/4S, 3.0, 3.0 4, 4.0 GTS/S 4 Diesel/Turbo/Turbo S E-Hybrid, Sport Turismo (3.0 4, 4.0 GTS/S 4 Diesel/Turbo/Turbo S E-Hybrid)
9PA				
A-2523			2003-2010 Cayenne	3.0 TDI, 3.2, 3.6, GTS 4.8, S 4.5/4.8, Turbo 4.5, Turbo S 4.5/4.8
A-2571			2003-2010 Cayenne	3.0 TDI, 3.2, 3.6, GTS 4.8, S 4.5/4.8, Turbo 4.5, Turbo S 4.5/4.8
A-2572			2003-2010 Cayenne	3.0 TDI, 3.2, 3.6, GTS 4.8, S 4.5/4.8, Turbo 4.5, Turbo S 4.5/4.8
AS-3164			2003-2010 Cayenne	3.0 TDI, 3.2, 3.6, GTS 4.8, S 4.5/4.8, Turbo 4.5, Turbo S 4.5/4.8
AS-3165			2003-2010 Cayenne	3.0 TDI, 3.2, 3.6, GTS 4.8, S 4.5/4.8, Turbo 4.5, Turbo S 4.5/4.8
C-2616			2003-2006 Cayenne	w/o PDCC, Gas Engine Only 3.2, 3.6, GTS 4.8, S 4.5/4.8, Turbo 4.5, Turbo S 4.5/4.8
P-2496	 OES		2003-2010 Cayenne	Gas Engine Only 3.0 TDI, 3.2, 3.6, GTS 4.8, S 4.5/4.8, Turbo 4.5, Turbo S 4.5/4.8







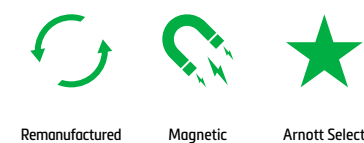
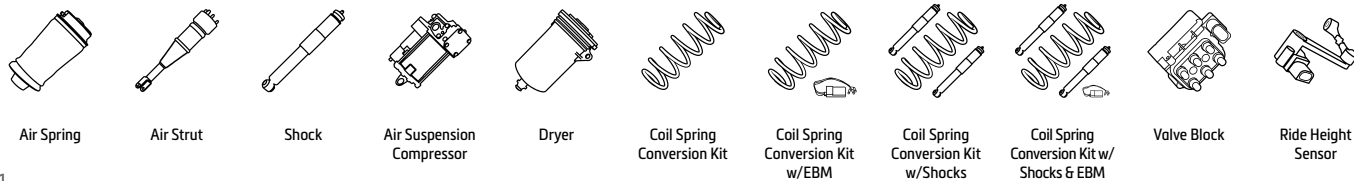





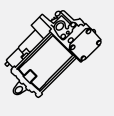

NEW RIDE HEIGHT SENSORS

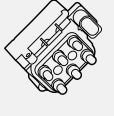



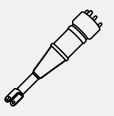

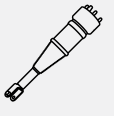
- Ride height sensors for 10-16 Porsche Panamera (970 Chassis)
- Direct OE replacement
- Fast plug & play installation
- RH-3714 (front right), RH-3715 (front left), RH-3716 (rear right) & RH-3717 (rear left)



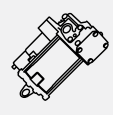

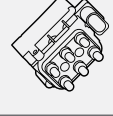

ENGINEERED TO RIDE, BUILT TO LAST.®

PORSCHE				
Part #	Product Type	Position	Model Information	Attributes
9PA				
VB-3470			2003-2010 Cayenne	3.0 TDI, 3.2, 3.6, GTS 4.8, S 4.5/4.8, Turbo 4.5, Turbo S 4.5/4.8
VB-3824			2003-2010 Cayenne	3.0 TDI, 3.2, 3.6, GTS 4.8, S 4.5/4.8, Turbo 4.5, Turbo S 4.5/4.8

RAM				
Part #	Product Type	Position	Model Information	Attributes
D2, DJ				
P-3241			2013-2018 1500	4.7/5.7 4x4
P-3480	 OES		2014-2021 2500	Crew Cab Pickup (5.7, 5.7 4WD, 6.7 D/D 4WD) Pickup (5.7) Standard Cab Pickup (5.7, 5.7 4WD, 6.7 D/D 4WD)
			2014-2021 3500	
VB-3470			2013-2018 2500	
			2013-2018 3500	
VB-3824			2013-2018 1500	
			2014-2021 2500	
			2014-2021 3500	
DS				
A-3016			2013-2018 1500	Crew Cab Pickup (3.6 4WD, 5.7, 5.7 4WD)
			2019-2020 1500 Classic	
AS-3017			2013-2018 1500	Crew Cab Pickup (3.6/5.7 4WD) Extended Cab Pickup (3.0 TD 4WD, 5.7, 5.7 4WD) Standard Cab Pickup (3.6/5.7, 3.6/5.7 4WD)
			2019-2020 1500 Classic	
AS-3618			2015-2018 1500 Rebel	Crew Cab Pickup (3.0 TD 4WD, 3.6 4WD) Extended Cab Pickup (3.0 TD 4WD) Standard Cab Pickup (3.6, 3.6 4WD)





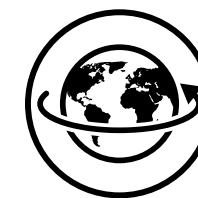
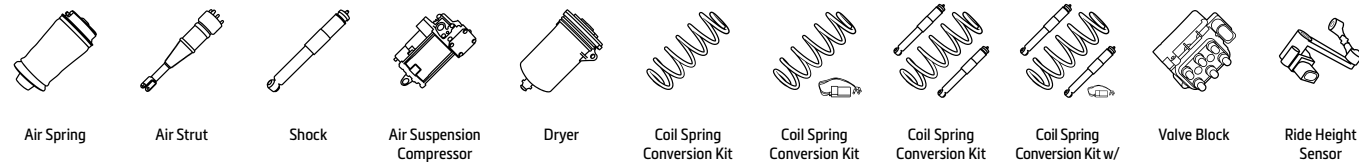





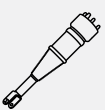

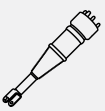

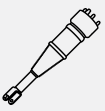

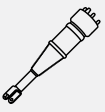

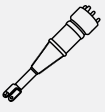
RAM							
Part #	Product Type	Position	Model Information	Attributes			
DS							
P-3241			2013-2018 1500	Crew Cab Pickup (3.6/5.7 4WD) Extended Cab Pickup (3.0 TD 4WD, 5.7, 5.7 4WD) Standard Cab Pickup (3.6/5.7, 3.6/5.7 4WD)			
				RH-3591		2013-2014 1500	Crew Cab Pickup (3.6/5.7 4WD) Extended Cab Pickup (3.0 TD 4WD, 5.7, 5.7 4WD) Standard Cab Pickup (3.0 TD 4WD, 3.6/5.7, 3.6/5.7 4WD)
							RH-3592
SK-3556			2013-2018 1500	Crew Cab Pickup (4WD) Extended Cab Pickup (4WD) Standard Cab Pickup (4WD)			
			2019-2020 1500 Classic	4WD			
VB-3470			2013-2018 1500	Crew Cab Pickup (3.6/5.7 4WD) Extended Cab Pickup (3.0 TD 4WD, 5.7, 5.7 4WD) Standard Cab Pickup (3.0 TD 4WD, 3.6/5.7, 3.6/5.7 4WD)			
				VB-3824		2013-2018 1500	Crew Cab Pickup (3.6/5.7 4WD) Extended Cab Pickup (3.0 TD 4WD, 5.7, 5.7 4WD) Standard Cab Pickup (3.0 TD 4WD, 3.6/5.7, 3.6/5.7 4WD)

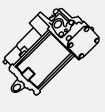

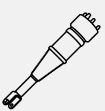

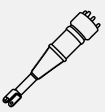

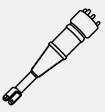





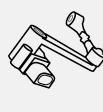

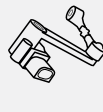
SAAB				
Part #	Product Type	Position	Model Information	Attributes
GMT360				
A-2610 (Gen. II)			2005-2009 9-7X	4.2/5.3 AWD
C-2137			2005-2009 9-7X	4.2/5.3 AWD

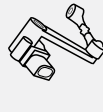

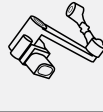
Global Leader in Air Suspension

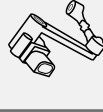

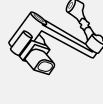



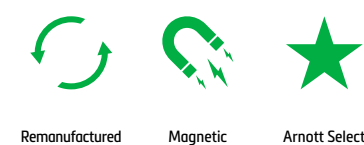
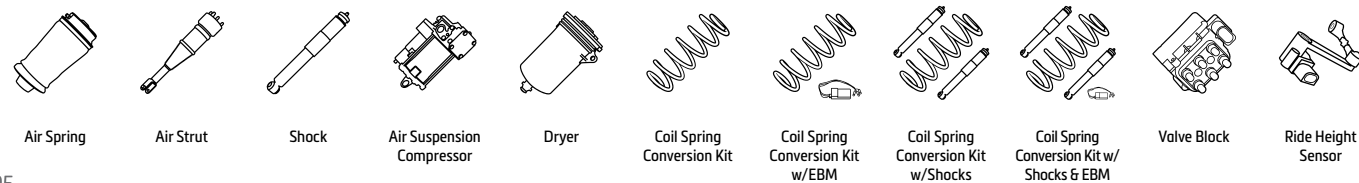



With over 30 years of experience, numerous innovations and patents, valuable installation resources, as well as world class warranties and customer support, Arnott is the Global Leader in aftermarket air suspension replacement products.

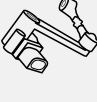

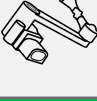











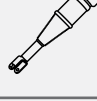

TESLA				
Part #	Product Type	Position	Model Information	Attributes
5YJS				
AS-3380			2016-2020 Model S	w/AWD 100D AWD, 60D AWD, 75D AWD, P100D AWD
AS-3381			2016-2020 Model S	w/AWD or RWD 100D AWD, 60, 60D AWD, 75, 75D AWD, P100D AWD
AS-3748			2016-2021 Model S	w/RWD 60, 70, 75
AS-3749			2016-2021 Model S	w/RWD 60, 70, 75
AS-3750			2016-2021 Model S	w/RWD 60, 70, 75
P-3283			2012-2016 Model S	w/AWD or RWD 60/D AWD, 85/D AWD, P85/D AWD
P-3509			2016-2021 Model S	w/AWD or RWD 100D AWD, 60, 60D AWD, 70, 70D AWD, 75, 75D AWD, 85, 85D AWD, 90D AWD, P100D AWD, P85D AWD, P90 AWD
5YJX				
AS-3175			2016-2020 Model X	100D AWD, 60D AWD, 75D AWD, 90D AWD, P100D AWD, P90D AWD
AS-3176			2016-2020 Model X	100D AWD, 60D AWD, 75D AWD, 90D AWD, P100D AWD, P90D AWD
AS-3751			2016 Model X	

TESLA				
Part #	Product Type	Position	Model Information	Attributes
5YJX				
AS-3752			2016 Model X	
TOYOTA				
Part #	Product Type	Position	Model Information	Attributes
1st Generation (XK30/40)				
P-3190			2005-2007 Sequoia	4.6/4.7/5.7, 4.7/5.7 4WD
RH-3778			2005-2007 Sequoia	4.6/4.7/5.7, 4.7/5.7 4WD
2nd Generation (XK60)				
P-3189			2008-2020 Sequoia	4.6, 4.7/4WD, 5.7/4WD/FLEX 4WD
RH-3768			2008-2020 Sequoia	4.6, 4.7/4WD, 5.7/4WD/FLEX 4WD
RH-3769			2008-2020 Sequoia	4.6, 4.7/4WD, 5.7/4WD/FLEX 4WD
J100				
RH-3764			2006-2007 Land Cruiser	4.2TD, 4.7
RH-3765			2006-2007 Land Cruiser	4.2TD, 4.7
RH-3770			2006-2007 Land Cruiser	4.2TD, 4.7

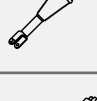
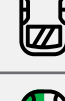
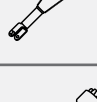

ENGINEERED TO RIDE, BUILT TO LAST.®

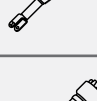
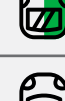
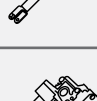
TOYOTA				
Part #	Product Type	Position	Model Information	Attributes
N210				
A-2949			2003-2009 4Runner	3.0 D/D-4D, 4.0/V6 VVT-i
P-3192	 OES		2003-2009 4Runner	3.0 D/D-4D, 4.0/V6 VVT-i
RH-3771			2006-2007 4Runner	2.7, 3.0 D/D-4D, 4.0/V6
RH-3772			2006-2007 4Runner	2.7, 3.0 D/D-4D, 4.0/V6
N280				
A-3331			2011-2018 4Runner	2.7, 2.8 D-4D, 3.0 D/D-4D/TDi, 3.5, 4.0 V6 Dual VVTi/V6 VVTi
A-3332			2011-2018 4Runner	2.7, 2.8 D-4D, 3.0 D/D-4D/TDi, 3.5, 4.0 V6 Dual VVTi/V6 VVTi







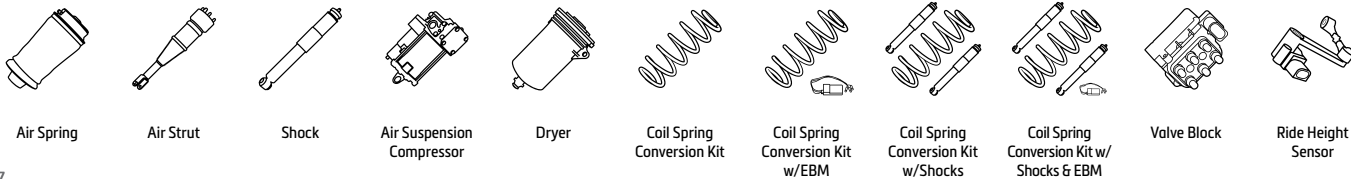

VOLKSWAGEN				
Part #	Product Type	Position	Model Information	Attributes
D1				
AS-2580			2003-2006 Phaeton	3D1, 3D2, 3D3, 3D4, 3D6, 3D7, 3D8, 3D9 - 3.0 V6 TDI 4motion, 3.2 V6/4motion, 4.2 V8 4motion, 5.0 V10 TDI 4motion, 6.0 W12 4motion
AS-2581			2003-2006 Phaeton	3D1, 3D2, 3D3, 3D4, 3D6, 3D7, 3D8, 3D9 - 3.0 V6 TDI 4motion, 3.2 V6/4motion, 4.2 V8 4motion, 5.0 V10 TDI 4motion, 6.0 W12 4motion
AS-2892			2003-2006 Phaeton	3D1, 3D2, 3D3, 3D4, 3D6, 3D7, 3D8, 3D9 - 3.0 V6 TDI 4motion, 3.2 V6/4motion, 4.2 V8 4motion, 5.0 V10 TDI 4motion, 6.0 W12 4motion
AS-2893			2003-2006 Phaeton	3D1, 3D2, 3D3, 3D4, 3D6, 3D7, 3D8, 3D9 - 3.0 V6 TDI 4motion, 3.2 V6/4motion, 4.2 V8 4motion, 5.0 V10 TDI 4motion, 6.0 W12 4motion
AS-2968			2003-2006 Phaeton	3D1, 3D2, 3D3, 3D4, 3D6, 3D7, 3D8, 3D9 - 3.0 V6 TDI 4motion, 3.2 V6/4motion, 4.2 V8 4motion, 5.0 V10 TDI 4motion, 6.0 W12 4motion
AS-2969			2003-2006 Phaeton	3D1, 3D2, 3D3, 3D4, 3D6, 3D7, 3D8, 3D9 - 3.0 V6 TDI 4motion, 3.2 V6/4motion, 4.2 V8 4motion, 5.0 V10 TDI 4motion, 6.0 W12 4motion
AS-3127			2003-2006 Phaeton	3D1, 3D2, 3D3, 3D4, 3D6, 3D7, 3D8, 3D9 - 3.2 V6/4motion, 4.2 V8 4motion, 5.0 V10 TDI 4motion, 6.0 W12 4motion
AS-3128			2003-2006 Phaeton	3D1, 3D2, 3D3, 3D4, 3D6, 3D7, 3D8, 3D9 - 3.2 V6/4motion, 4.2 V8 4motion, 5.0 V10 TDI 4motion, 6.0 W12 4motion
AS-3129			2003-2006 Phaeton	3D1, 3D2, 3D3, 3D4, 3D6, 3D7, 3D8, 3D9 - 3.0 V6 TDI 4motion, 3.2 V6/4motion, 4.2 V8 4motion, 5.0 V10 TDI 4motion, 6.0 W12 4motion
AS-3130			2003-2006 Phaeton	3D1, 3D2, 3D3, 3D4, 3D6, 3D7, 3D8, 3D9 - 3.0 V6 TDI 4motion, 3.2 V6/4motion, 4.2 V8 4motion, 5.0 V10 TDI 4motion, 6.0 W12 4motion
P-2740	 OES		2003-2006 Phaeton	3D1, 3D2, 3D3, 3D4, 3D6, 3D7, 3D8, 3D9 - 3.0 V6 TDI 4motion, 3.2 V6/4motion, 4.2 V8 4motion, 5.0 V10 TDI 4motion, 6.0 W12 4motion









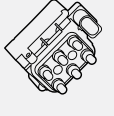
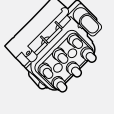

Arnott's engineers test every product for form, fit and functionality in both a lab setting and on the company's extensive fleet of vehicles.

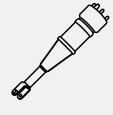
Extensive Testing

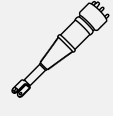

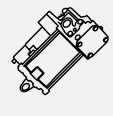
VOLKSWAGEN				
Part #	Product Type	Position	Model Information	Attributes
VW 7L				
A-2523			2004-2010 Touareg	7LA, 7L6, 7L7 - 2.5 R5 TDI, 3.0 TDI/V6 TDI, 3.2 V6, 3.6 V6 FSI, 4.2 V8/V8 FSI, 5.0 R50 TDI/V10 TDI, 6.0 W12
A-2571			2004-2010 Touareg	7LA, 7L6, 7L7 - 2.5 R5 TDI, 3.0 TDI/V6 TDI, 3.2 V6, 3.6 V6 FSI, 4.2 V8/V8 FSI, 5.0 R50 TDI/V10 TDI, 6.0 W12
A-2572			2004-2010 Touareg	7LA, 7L6, 7L7 - 2.5 R5 TDI, 3.0 TDI/V6 TDI, 3.2 V6, 3.6 V6 FSI, 4.2 V8/V8 FSI, 5.0 R50 TDI/V10 TDI, 6.0 W12
C-3419			2004-2010 Touareg	7LA, 7L6, 7L7 - 2.5 R5 TDI, 3.0 TDI/V6 TDI, 3.2 V6, 3.6 V6 FSI, 4.2 V8/V8 FSI, 5.0 R50 TDI/V10 TDI, 6.0 W12
P-2496	 OES		2004-2010 Touareg	7LA, 7L6, 7L7 - 2.5 R5 TDI, 3.0 TDI/V6 TDI, 3.2 V6, 3.6 V6 FSI, 4.2 V8/V8 FSI, 5.0 R50 TDI/V10 TDI, 6.0 W12
VB-3470			2004-2010 Touareg	7LA, 7L6, 7L7 - 2.5 R5 TDI, 3.0 TDI/V6 TDI, 3.2 V6, 3.6 V6 FSI, 4.2 V8/V8 FSI, 5.0 R50 TDI/V10 TDI, 6.0 W12
VB-3824			2004-2010 Touareg	7LA, 7L6, 7L7 - 2.5 R5 TDI, 3.0 TDI/V6 TDI, 3.2 V6, 3.6 V6 FSI, 4.2 V8/V8 FSI, 5.0 R50 TDI/V10 TDI, 6.0 W12

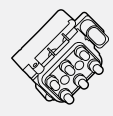
VOLVO				
Part #	Product Type	Position	Model Information	Attributes
SPA Platform				
A-3307			2016-2020 XC90	w/Auto-Leveling, Excl. Hybrid 2.0 T5 AWD/T6 AWD, D4/AWD, D5 AWD, T5 AWD, T6 AWD/Polestar AWD
			2017-2020 V90 Cross Country	w/Auto-Leveling, Excl. Hybrid 2.0 D3/2.0 D3 AWD/D4/D4 AWD/D5 AWD/Polestar AWD/T4/T5/T5 AWD/T6 AWD
			2018-2020 XC60	w/Auto-Leveling, Excl. Hybrid 2.0 D3/D4/D4 AWD/D4 Polestar AWD/D5 AWD/T4/T5/T5 AWD/T5 Polestar AWD/T6 AWD/T6 Polestar AWD
AS-3343			2016-2019 XC90	w/Auto-Leveling, Excl. Hybrid 2.0 D5 Polestar AWD/T5 AWD/T6 AWD, D4/AWD, D5 AWD, T5 AWD/Polestar AWD, T6 AWD/Polestar AWD, T8 Twin Engine AWD
AS-3344			2016-2019 XC90	w/Auto-Leveling, Excl. Hybrid 2.0 D5 Polestar AWD/T5 AWD/T6 AWD, D4/AWD, D5 AWD, T5 AWD/Polestar AWD, T6 AWD/Polestar AWD, T8 Twin Engine AWD
P-3476			2016-2020 XC90	w/Auto-Leveling, Excl. Hybrid 2.0 T5/6 AWD, D4, D4/5 AWD, T5/6 AWD
			2017-2020 S90	w/Auto-Leveling, Excl. Hybrid 2.0 (D3/4, 2.0 D4/5 AWD, D5 Polestar AWD, T4/5, T5 Drive-E Polestar, T6 AWD/Drive-E Polestar AWD), D4 Drive-E Polestar
			2017-2020 V90 Cross Country	w/Auto-Leveling, Excl. Hybrid 2.0 (D3/4, D3 AWD, D4/5 AWD, T4/5, T5 AWD/Polestar/Polestar AWD, T6 AWD/Polestar AWD
VB-3470			2016-2020 XC90	w/Auto-Leveling, Excl. Hybrid 2.0 T5 AWD/T6 AWD, D4/AWD, D5 AWD, T5 AWD, T6 AWD/Polestar AWD
			2018-2020 XC60	w/Auto-Leveling, Excl. Hybrid 2.0 (D3/4, D4/5 AWD, D5 Polestar AWD, T5, T5 AWD/Polestar AWD, T6 AWD/Polestar AWD), T5 Polestar, T5/6 Polestar AWD
VB-3824			2016-2020 XC90	w/Auto-Leveling, Excl. Hybrid 2.0 T5 AWD/T6 AWD, D4/AWD, D5 AWD, T5 AWD, T6 AWD/Polestar AWD
			2018-2020 XC60	w/Auto-Leveling, Excl. Hybrid 2.0 D3/D4/D4 AWD/D4 Polestar AWD/D5 AWD/T4/T5/T5 AWD/T5 Polestar AWD/T6 AWD/T6 Polestar AWD

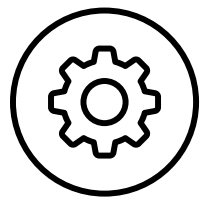

Arnott's commitment to OE quality form, fit and function begins with exhaustive engineering. Arnott's advanced designs are not only more durable, but many are also easier to install than their OE counterparts.

Innovative Engineering

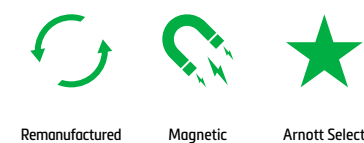
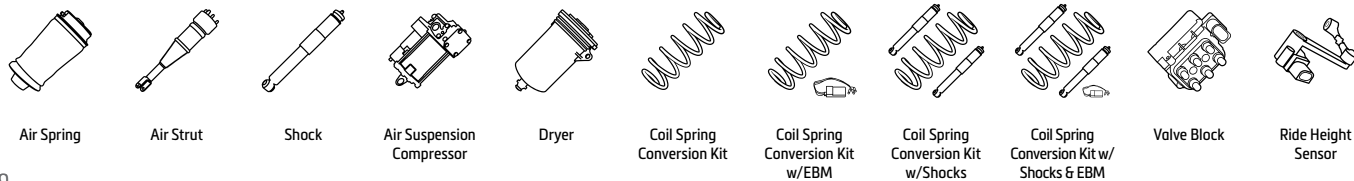

ENGINEERED TO RIDE, BUILT TO LAST.

ARNOTT-DESIGNED NEW AIR STRUTS

- Custom-valved shock adapts to driving style
- Premium brand air sleeve, bump stop & dust boot
- Works with vehicle's auto leveling functionality
- CNC-machined aluminum or stamped steel top
- Improved seals to prevent leaks
- Many connect to ADS system to eliminate warning lights
- Engineered & assembled in the USA
- Limited Lifetime Warranty on Arnott-branded products

REMANUFACTURED AIR STRUTS

- Tested, cleaned & recharged OE shock
- New sealing cap & air line fitting
- Works with vehicle's auto damping & leveling system
- Premium air sleeve, bump stop, air fitting & dust boot
- OE top mount & sensor
- Remanufactured in the USA
- Limited Lifetime Warranty on Arnott-branded products

MAGNETIC RIDE SHOCKS

Magnetic Ride Shocks are now offered in Arnott's aftermarket suspension product line. Designed as a direct replacement for GM SUVs with the magnetorheological damper system Z95 RPO, Arnott's OES magnetic shocks provide the same adaptive ride as the OE.



What are Magnetic Ride Shocks?

Magnetic Ride Shocks consist of a monotube damper filled with a combination of synthetic hydrocarbon oil and readily magnetized iron particles (the sum of which is known as magnetorheological fluid) as well as electromagnetic coils. Maintaining the system are a sensor set and an Electronic Control Unit (ECU).

How do Magnetic Ride Shocks work?

If the vehicle sensors detect a change in road conditions, a signal is sent to the ECU. The ECU then determines the electromagnetic current strength required for each shock. When activated, the electromagnetic coils create a magnetic field that instantly magnetizes the iron particles, increasing the viscosity of the magnetorheological fluid and suspension stiffness.

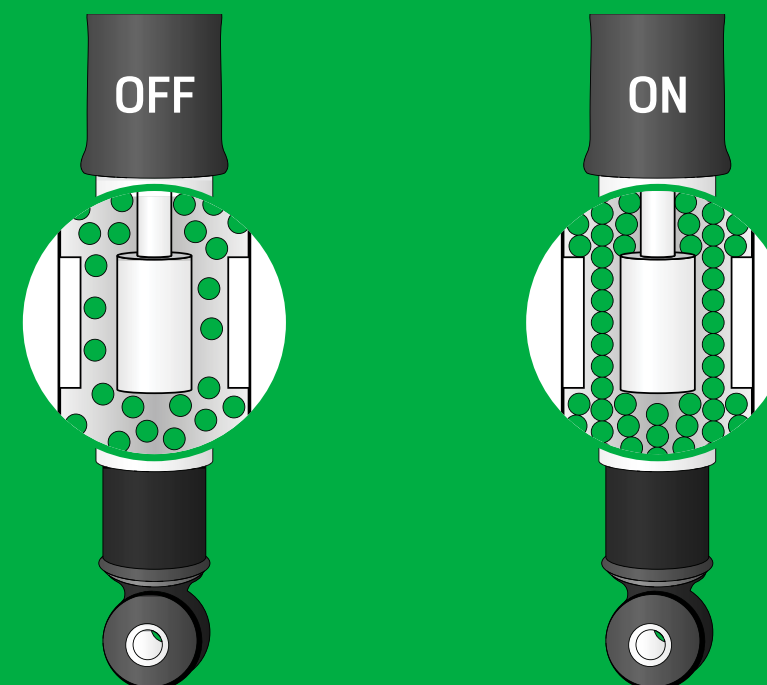



AIR SPRINGS

- Premium name-brand air sleeve
- Faster, easier installation
- Engineered & assembled in the USA
- Compatible with OE struts, air line & leveling system
- High-impact polyurethane or aircraft-quality aluminum



AIR SUSPENSION COMPRESSORS

- Compressors meet OE specifications
- Includes thermal overload protection
- Electrocoated epoxy finish to prevent corrosion
- Extensive life-cycle testing
- Most mate with OE lines & plugs for ease of installation
- Limited Lifetime Warranty on Arnott-branded products



COIL SPRING CONVERSION KITS

- Patented Electronic Bypass Module (EBM) eliminates fault codes
- Custom-valved shock absorbers
- Durable American-made, powder-coated coil springs
- Pre-assembled for easy & safe installation
- OE fit with no modifications needed

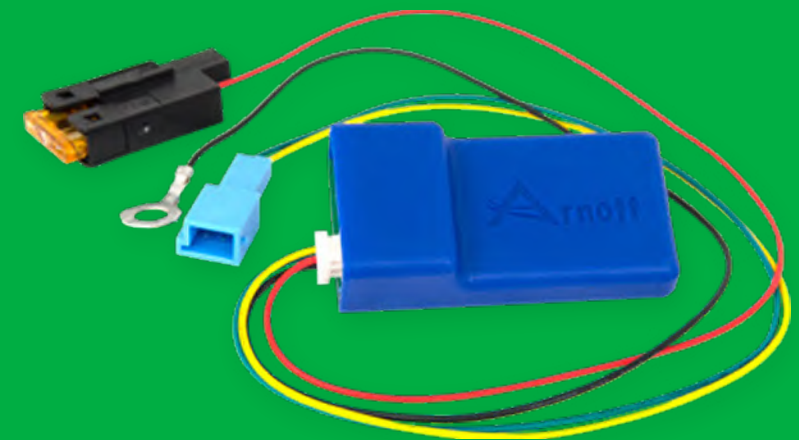



SOLENOID VALVE BLOCKS

- Distributes air pressure within the air suspension system
- Direct OE replacement
- Designed to meet or exceed OE
- Helps restore original air suspension system
- Growing product category



RIDE HEIGHT SENSORS

- Determines vehicle height
- Tested to 1 million cycles
- Road tested for function & fitment
- Direct fit for fast, plug & play installation
- Quality components including hardware & mounting points for long service life

ENGINEERED TO RIDE, BUILT TO LAST.®

Visit us online for the latest product releases, company news, demos & tutorials:

ARNOTTINC.COM



@ArnettInc



@ArnettAir



@ Arnett Industries

The air suspension experts at Arnett offer a comprehensive product line at an exceptional value backed by best-in-class support – from purchase to installation and beyond!



THE ARNOTT ADVANTAGE

- Expert technical support
- Se habla español
- Satisfaction guaranteed
- Over 30 years of customer satisfaction
- Better Business Bureau - A+ Rating
- Limited Lifetime Warranty on Arnett-branded products

Our Customer Service team is readily available to assist you with choosing and ordering the right Arnett product for your needs. They can also provide updates on order status, product availability or help with any technical questions you might have regarding Arnett's air suspension products.

Arnett US Business Office:

100 Sea Ray Drive
Merritt Island, FL 32953

Call: 800.251.8993
321.868.3016
Fax: 321.868.3703
Email: catalogfeedback@arnottinc.com

Arnett Europe Business Office:

Docterskampstraat 1E/1F, 3
5222 AM 's-Hertogenbosch (NL)

NL Phone: +31 73 7850 580
DE Phone: +31 85 2087 438
UK Phone: +44 203 3186 124
BE Phone: +32 258 846 90
ES Phone: +34 91 901 10 56
FR Phone: +33 18 626 72 41
Email: info@arnotteurope.com





ENGINEERED TO RIDE, BUILT TO LAST.®



Air Springs



Struts



Shocks



Compressors



Dryers



Coil Spring
Conversion Kits

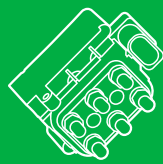

Valve Blocks



Ride Height
Sensors